

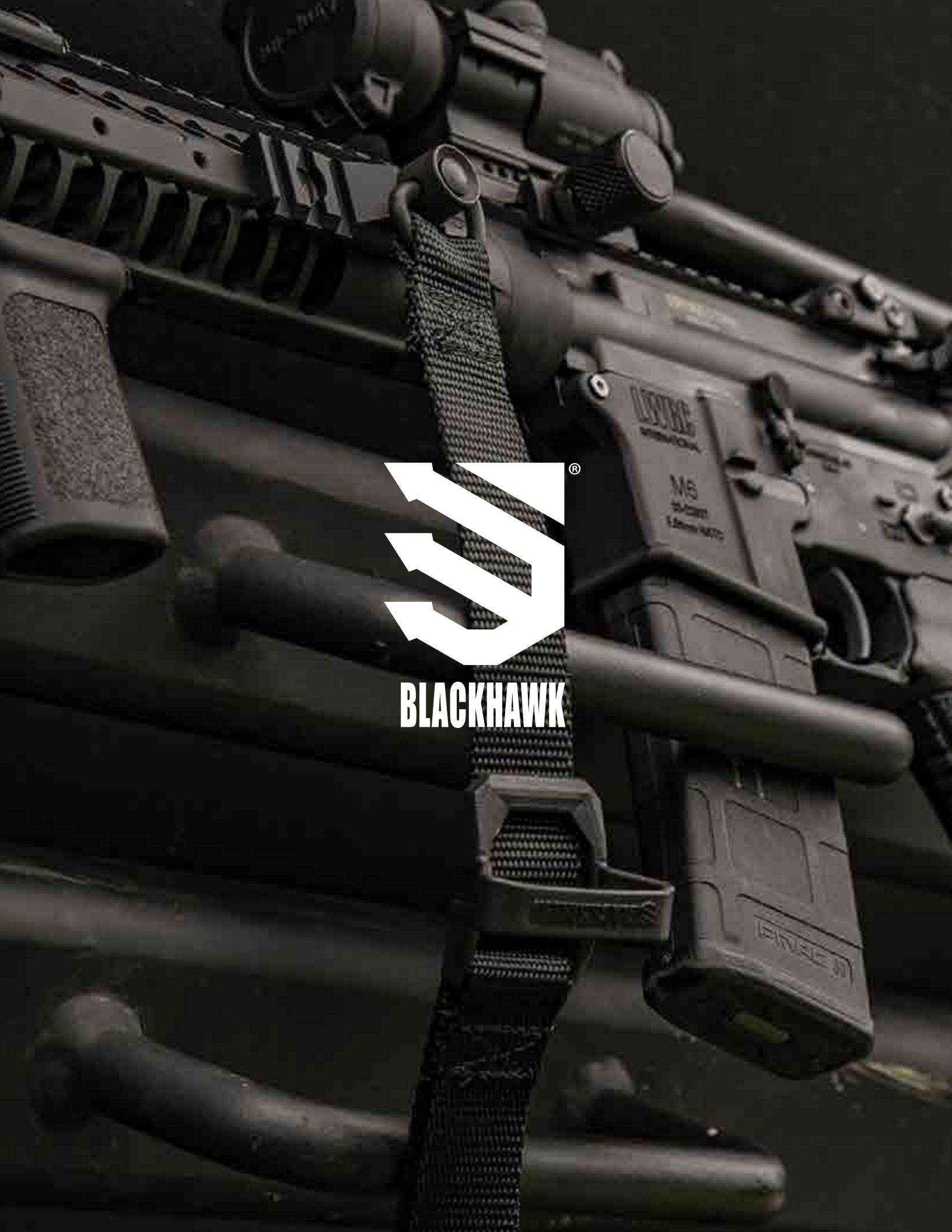

 **BLACKHAWK[®]**

CATALOG 2020



BLACKHAWK

HOLSTERS	05-31
DUTY	05
CONCEALMENT	08
SPORTSTER	11
TACTICAL	14
PLATFORMS/ACCESSORIES	16
ACCESSORIES	29
DUTY + PROTECTIVE	33-57
ENTRY TOOLS	33
PLATE CARRIERS	44
RIGS	45
VESTS	50
BELTS	54
APPAREL	59-67
OUTERWEAR	59
HEADWEAR	60
FOOTWEAR	62
KNEE/ELBOW PADS	63
GLOVES	64
BAGS + PACKS	69-81
BAGS	69
PACKS	73
ACCESSORIES + BELT MOUNTED	76
CASES	77
MATS	80
ACCESSORIES	83-109
SLINGS + SLING MOUNTS	83
ON-GUN COMPONENTS	91
POUCHES	97
MISCELLANEOUS	108

HOLSTERS

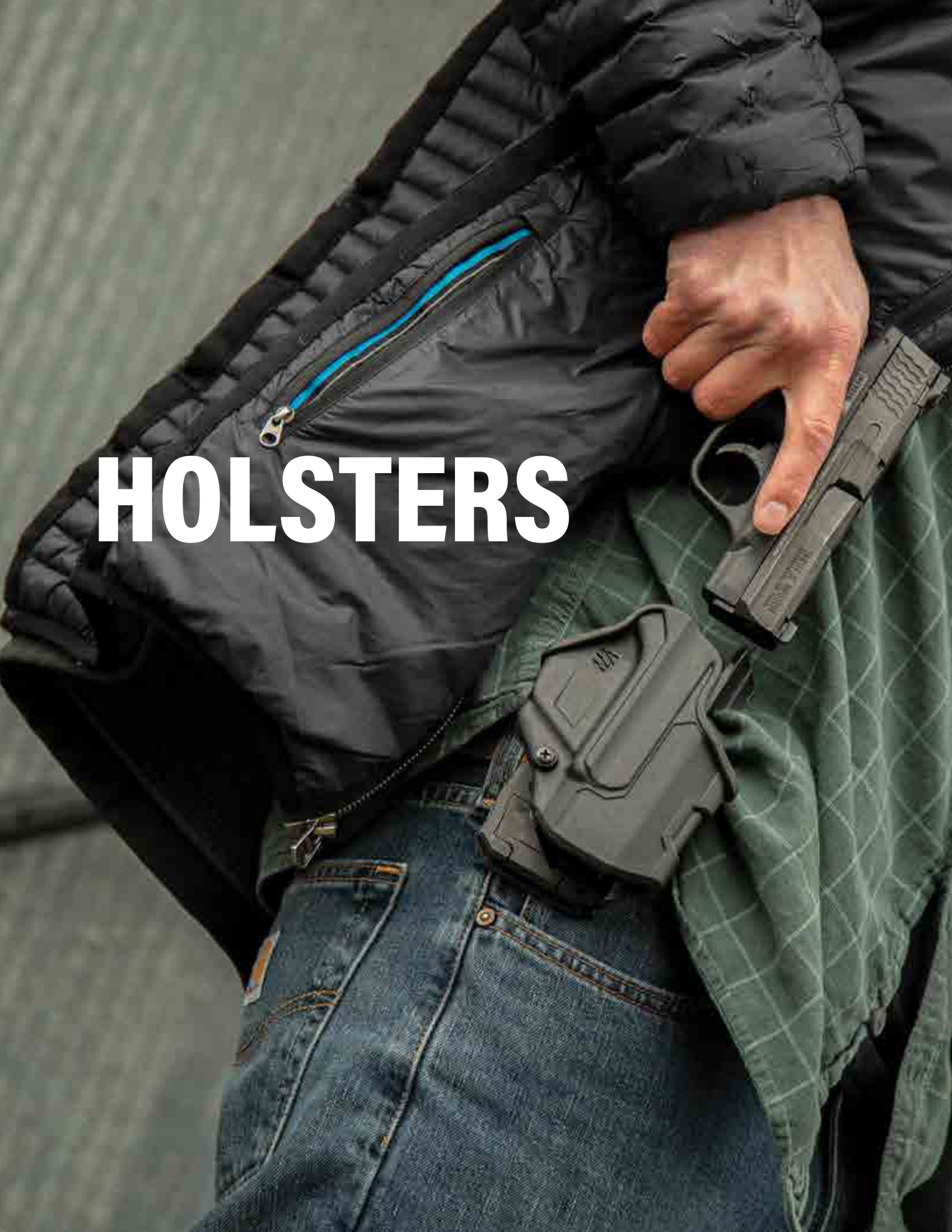

DUTY HOLSTERS

T-SERIES® L2D DUTY HOLSTER



- Thumb-activated retention utilizing Master Grip Principle
- Low-friction internal material creates a smooth, effortless draw
- Sound-dampening lining for stealthy drawing and re-holstering
- Durable polymer construction provides protection with minimal bulk
- Full-coverage design protects rear sight



MATTE FINISH

Part Number	Fit	Color
44N100BKL	Glock 17/19/22/23/31/32/45/47	Black
44N100BKR	Glock 17/19/22/23/31/32/45/47	Black
44N161BKL	Sig P320/P250/M17/M18	Black
44N161BKR	Sig P320/P250/M17/M18	Black

LIGHT BEARING

Part Number	Fit	Color
44N200BKL	Glock 17/19/22/23/31/32/47 w TLR 1/2	Black
44N200BKR	Glock 17/19/22/23/31/32/47 w TLR 1/2	Black
44N261BKL	Sig P320/P250/M17/M18 w TLR 1/2	Black
44N261BKR	Sig P320/P250/M17/M18 w TLR 1/2	Black
44N213BKL	Glock 20/21/37/38 & S&W M&P W/O Safety, SD 9/.40 w TLR 1/2	Black
44N213BKR	Glock 20/21/37/38 & S&W M&P W/O Safety, SD 9/.40 w TLR 1/3	Black
44N300BKR	Glock 17/19/22/23/31/32/45/47 W/TLR 7/8	Black
44N300BKL	Glock 17/19/22/23/31/32/45/47 W/TLR 7/8	Black
44N361BKR	Sig P320/P250/M17/M18 W/TLR 7/8	Black
44N361BKL	Sig P320/P250/M17/M18 W/TLR 7/8	Black



T-SERIES® L3D DUTY HOLSTER



- Thumb-activated retention utilizing Master Grip Principle
- Low-friction internal material creates a smooth, effortless draw
- Sound-dampening lining for stealthy drawing and re-holstering
- Durable polymer construction provides protection with minimal bulk
- Full-coverage design protects rear sight
- Level 3 retention secures back of slide



Part Number	Fit	Color
44N500BKL	Glock 17/19/22/23/31/32/45/47	Black
44N500BKR	Glock 17/19/22/23/31/32/45/47	Black
44N561BKL	Sig P320/P250/M17/M18	Black
44N561BKR	Sig P320/P250/M17/M18	Black

LIGHT BEARING

Part Number	Fit	Color
44N600BKL	Glock 17/19/22/23/31/32/45/47 w TLR 1/2	Black
44N600BKR	Glock 17/19/22/23/31/32/45/47 w TLR 1/2	Black
44N661BKL	Sig P320/P250/M17/M18 w TLR 1/2	Black
44N661BKR	Sig P320/P250/M17/M18 w TLR 1/2	Black
44N700BKR	Glock 17/19/22/23/31/32/45/47 W/TLR 7/8	Black
44N700BKL	Glock 17/19/22/23/31/32/45/47 W/TLR 7/8	Black
44N761BKR	Sig P320/P250/M17/M18 W/TLR 7/8	Black
44N761BKL	Sig P320/P250/M17/M18 W/TLR 7/8	Black



SERPA® LEVEL 2 AUTO LOCK™ DUTY HOLSTER



- SERPA® Auto Lock™ release
- Passive retention detent adjustment screw
- Full-length holster body protects rear sights
- Includes unique SERPA® Jacket Slot Belt Loop to attach to belt without unthreading other gear
- Mid-Ride Duty Belt Loop and High-Ride Duty Belt Loop also available (sold separately)
- Fits all Blackhawk injection-molded platforms



Part Number	Fit	Color	Size
44H000BK-R	Glock 17/19/22/23/31/32	Black	00
44H000BK-L	Glock 17/19/20/21/22/23/31/32 and S&W M&P 9/.40	Black	00
44H003BK-R or L	Gov't 1911 and some Clones with or without Rails	Black	03
44H004BK-R or L	Beretta 92/92A1/96/96A1/M9/M9A1 (not Brig./Elite)	Black	04
44H006BK-R or L	Sig 220/225/226/228/229 with or without Rails	Black	06
44H008BK-R or L	Sig Pro 2022	Black	08
44H013BK-R	Glock 20/21/21SF/37/38 and S&W M&P (All Models) with or without Rails (Not 2.0)	Black	13
44H026BK-R	Glock 21SF with Larger 1913 Rails	Black	26

SERPA® LEVEL 3 AUTO LOCK™ DUTY HOLSTER



- SERPA® Auto Lock™ release
- Passive retention detent adjustment screw
- Thumb-activated Pivot Guard for additional security
- Full-length holster body protects rear sights
- Includes innovative SERPA® Jacket Slot Belt Loop
- Mid-Ride Duty Belt Loop and High-Ride Duty Belt Loop also available (sold separately)
- Fits all Blackhawk injection-molded platforms



MATTE FINISH

Part Number	Fit	Color	Size
44H100BK-R or L	Glock 17/19/22/23/31/32	Black	00
44H103BK-R	Gov't 1911 and some Clones with or without Rails	Black	03
44H104BK-R or L	Beretta 92/96/M9/M9A1 (Not For Brig./Elite/92A1/96A1)	Black	04
44H106BK-R or L	Sig 220/225/226/228/229 with or without Rails	Black	06
44H107BK-R or L	Springfield XD/XDM	Black	07
44H108BK-R or L	Sig Pro 2022	Black	08
44H109BK-R	H&K USP Compact/P2000 (Euro)	Black	09
44H110BK-R	S&W 5946	Black	10
44H113BK-R or L	Glock 20/21/21SF (Not 1913 Rail)/37/38)	Black	13
44H116BK-R or L	H&K P2000 (US)	Black	16
44H114BK-R	H&K Full Size USP 9/.40	Black	14
44H117BK-R or L	H&K P30	Black	17
44H124BK-R or L	Walther P99	Black	24
44H125BK-R or L	S&W M&P 9/.40 with or without Thumb Safety (Not 2.0)	Black	25
44H145BK-R or L	S&W M&P .45 and 9/.40 Pro with or without Thumb Safety (Not 2.0)	Black	45
44H179BK-R or L	H&K SFP9/VP9	Black	79



BASKETWEAVE FINISH

Part Number	Fit	Color	Size
44H100BW-R or L	Glock 17/19/22/23/31/32	Black	00
44H103BW-R	Gov't 1911 and some Clones with or without Rails	Black	03
44H104BW-R	Beretta 92/96/M9/M9A1 (Not For Brig./Elite/92A1/96A1)	Black	04
44H106BW-R or L	Sig 220/225/226/228/229 with or without Rails	Black	06
44H107BW-R or L	Springfield XD/XDM	Black	07
44H109BW-R or L	H&K USP Compact/P2000 (Euro)	Black	09
44H110BW-R or L	S&W 5946	Black	10
44H113BW-R or L	Glock 20/21/21SF (Not 1913 Rail)/37/38	Black	13
44H116BW-R or L	H&K P2000 (US)	Black	16
44H114BW-R or L	H&K USP Full Size 9/.40	Black	14
44H125BW-R or L	S&W M&P 9/.40 with or without Thumb Safety (Not 2.0)	Black	25
44H145BW-R or L	S&W M&P .45 and 9/.40 Pro with or without Thumb Safety (Not 2.0)	Black	45



TASER® X26/X26P, X2 LEVEL 2 DUTY HOLSTER



- Automatically engages the safety when re-holstering
- Holster bottom is configured to block the probes in case of accidental activation
- Trigger and trigger guard are completely enclosed inside holster
- Carries TASER® X26/X26P, X2 with optional camera unit attached
- Extended coverage protects polycarbonate digital readout window
- Belt loop fits most duty belts
- Rigid holster body delivers improved retention
- Protects cartridge in holster
- Designed to hold the TASER® X26 Cartridge Holder (sold separately)



Part Number	Description	Color	Size
44H015BK R or L	Taser® X26 Level 2 Duty Holster Matte	Black	15
44H015BW R or L	Taser® X26 Level 2 Duty Holster Basketweave	Black	15
44HT00BK R or L	Taser® X26P Level 2 Duty Holster Matte	Black	15
44HT01BK R or L	Taser® X2 Level 2 Duty Holster Matte	Black	15

CONCEALMENT HOLSTERS

T-SERIES® L2C CONCEALMENT HOLSTER



- Thumb-activated retention utilizing Master Grip Principle
- Low-friction internal material creates a smooth, effortless draw
- Sound-dampening lining for stealthy drawing and re-holstering
- Durable polymer construction provides protection with minimal bulk
- Low-profile design compatible with slide-mounted red-dot optics
- Speed-cut design for rapid draw, target acquisition, and re-holster



MATTE FINISH

Part Number	Fit	Color
410700BKL	Glock 17/22/31/34/35/41/47	Black
410700BKR	Glock 17/22/31/34/35/41/47	Black
410701BKR	Glock 19/23/26/27/32/33/45	Black
410757BKR	S&W M&P 9/.40/.45, SD9/.40 & Taurus PT 24/7 Pro	Black
410759BKR	S&W M&P Shield 9/.40	Black
410761ABKR	Sig P320/P250/M17/M18	Black
410761BKL	Sig P320/P250/M17/M18	Black
410768BKR	Glock 43/43X & Kahr PM9/PM40	Black
410770BKR	Sig P365/P365XL	Black
410776BKR	Glock 48 & S&W Shield M&P 380 EZ	Black

LIGHT BEARING

Part Number	Fit	Color
410200BKL	Glock 17/19/22/23/31/32/45/47 w TLR 7/8	Black
410200BKR	Glock 17/19/22/23/31/32/45/47 w TLR 7/8	Black
410261BKR	Sig P320/P250/M17/M18 w TLR 7/8	Black

SERPA® CQC® CONCEALMENT HOLSTER



- SERPA® Auto Lock™ release
- Passive retention detent adjustment screw
- Speed-cut design for rapid draw, target acquisition and re-holster
- Includes Belt Loop Platform and Paddle Platform
- Fits Shoulder, S.T.R.I.K.E.®, Quick Disconnect and Tactical Holster Platforms



MATTE FINISH

Part Number	Fit	Color	Size	NSN#
410500BK-R or L	Glock 17/22/31	Black	00	
410500CT-R	Glock 17/22/31	Coyote Tan	00	
410501BK-R or L	Glock 26/27/33	Black	01	
410502BK-R or L	Glock 19/19X/23/32/45	Black	02	1095-01-571-6864 (R)
410502CT-R	Glock 19/19X/23/32/45	Coyote Tan	02	
410503BK-R or L	Gov't 1911 and some Clones with or without Rails	Black	03	
410503CT-R or L	Gov't 1911 and some Clones with or without Rails	Tan	03	
410504BK-R or L	Beretta 92/96/M9 (Not Elite, Brig. or M9A1)	Black	04	
410504CT-R or L	Beretta 92/96/M9 (Not Elite, Brig. or M9A1)	Tan	04	
410505BK-R	Sig 228/229/250DC with or without Rails	Black	05	1095-01-573-2161
410506BK-R or L	Sig 220/225/226/228/229 with or without Rails	Black	06	1095-01-560-2097 (R) 1095-01-560-2098 (L)
410506CT-R or L	Sig 220/225/226/228/229 with or without Rails	Tan	06	1095-01-560-6029 (R) 1095-01-560-6028 (L)
410507BK-R or L	Springfield XD/Mod2/XDM 3.8"-4"	Black	07	
410507CT-R	Springfield XD/XDM 3.8" - 4"	Coyote Tan	07	
410508BK-R or L	Sig Pro 2022	Black	08	
410509BK-R	H&K USP Compact	Black	09	
410509BK-L	H&K P2000/USP Compact	Black	09	
410510BK-R or L	S&W 5900/4000 9/.40 Series Incl. TSW	Black	10	
410511BK-R	Ruger P85/89	Black	11	
410512BK-R	Ruger P95	Black	12	
410513BK-R or L	Glock 20/21/37, S&W M&P .45 and 9/.40 Pro	Black	13	
410513CT-R	Glock 20/21/37, S&W M&P .45 and 9/.40 Pro	Coyote Tan	13	
410514BK-R or L	H&K USP Full Size 9/.40	Black	14	8465-01-555-1503 (R), 8465-01-554-1462 (L)
410514CT-R	H&K USP Full Size 9/40	Coyote Tan	14	
410516BK-R	H&K P2000 (Not SK)	Black	16	
410517BK-R or L	H&K P30 (Not SK)	Black	17	
410519BK-R	Taurus 24/7 OSS 9/40	Black	19	
410520BK-R or L	S&W J-Frame Revolvers 2" (Not .357)	Black	20	
410524BK-R or L	Walther P99	Black	24	
410525BK-R or L	S&W M&P 9/.40 and Sigma (Not 2.0)	Black	25	
410525CT-R	S&W M&P 9/357/40	Coyote Tan	25	
410528BK-R	Beretta PX4 Storm (Not Sub Compact)	Black	28	
410530BK-R	Glock 29/30/39 (Not 30S)	Black	30	
410531BK-R or L	Springfield XD/Mod2 Sub-Compact	Black	31	
410532BK-R	Taurus 85 2" 5-Shot .38 (Some Models)	Black	32	
410538BK-R	Glock 38	Black	38	
410540BK-R	Taurus Judge (2.5" Cylinder)	Black	40	
410541BK-R	Ruger SR9/9E	Black	41	
410542BK-R	Commander 1911 and some Clones with or without rails	Black	42	
410543BK-R or L	Caracal F	Black	43	
410544BK-R	Taurus Judge (3" Cylinder)	Black	44	
410563BK-R or L	S&W M&P Shield (9/40 only/Not 2.0)	Black	63	
410565BK-R or L	Springfield XDS 3.3	Black	65	
410567BK-R or L	Glock 42	Black	67	
410583BK-R	Taurus PT111/PT140 (not G2C)	Black	83	
410579BK-R or L	H&K SFP9/VP9/VP40 (Not SK)	Black	79	

CARBON FIBER FINISH

Part Number	Fit	Color	Size	NSN#
410000BK-R or L	Glock 17/22 /31	Black	00	1095-01-578-7344 (L)
410001BK-R or L	Glock 26/27/33	Black	01	
410002BK-R or L	Glock 19/23/32/36	Black	02	
410003BK-R or L	Gov't 1911 and some Clones with or without Rails	Black	03	
410004BK-R or L	Beretta 92/96/M9 (Not Elite, Brig. or M9A1)	Black	04	
410005BK-R	Sig 228/229/250DC with or without Rails	Black	05	
410006BK-R or L	Sig 220/225/226/228/229 with or without Rails	Black	06	1095-01-614-1639 (R), 1095-01-614-1164 (L)
410007BK-R or L	Springfield XD/Mod2/XDM 3.8" – 4"	Black	07	
410008BK-R or L	Sig Pro 2022	Black	08	
410009BK-R	H&K USP Compact	Black	09	
410009BK-L	H&K P2000/USP Compact	Black	09	
410010BK-R or L	S&W 5900/4000 9/.40 Incl. TSW	Black	10	
410011BK-R	Ruger P85/89	Black	11	
410012BK-R	Ruger P95	Black	12	
410013BK-R or L	Glock 20/21/37, S&W M&P .45 and 9/.40 Pro (not 2.0)	Black	13	
410014BK-R or L	H&K USP Full Size 9/.40	Black	14	
410016BK-R	H&K P2000	Black	16	
410017BK-R or L	H&K P30	Black	17	
410018BK-R or L	FN 5.7 USG MKI/MKII	Black	18	
410019BK-R	Taurus 24/7 OSS 9/40	Black	19	
410024BK-R or L	Walther P99	Black	24	
410025BK-R or L	S&W M&P 9/.40 and Sigma (not 2.0)	Black	25	
410028BK-R	Beretta PX4 Storm (Not Sub Compact)	Black	28	
410029BK-R	Taurus 24/7 9/40	Black	29	
410030BK-R	Glock 29/30/39	Black	30	
410031BK-R or L	Springfield XD/Mod2 Sub-Compact	Black	31	
410041BK-R	Ruger SR9/9E	Black	41	
410042BK-R	Commander 1911 and some Clones with or without Rails	Black	42	
410043BK-R or L	Caracal F	Black	43	

SPORTSTER HOLSTERS

SERPA® SPORTSTER® HOLSTER



- SERPA® Auto Lock™ release
- Passive retention detent adjustment screw
- Gunmetal grey holster body with black locking mechanism
- Speed-cut design for rapid draw, target acquisition and re-holster
- Includes paddle platform only
- Fits Shoulder, S.T.R.I.K.E.®, Quick Disconnect and Tactical Holster Platforms



Part Number	Description	Color	Size
413500BK-R or L	Glock 17/22/31	Gunmetal Grey	00
413501BK-R or L	Glock 26/27/33	Gunmetal Grey	01
413502BK-R or L	Glock 19/23/32/36	Gunmetal Grey	02
413503BK-R or L	Gov't 1911 & Clones with or without Rails	Gunmetal Grey	03
413504BK-R or L	Beretta 92/96/M9 (Not Elite, Brig. or M9A1)	Gunmetal Grey	04
413505BK-R	Sig 228/229/250DC with or without Rails	Gunmetal Grey	05
413506BK-R or L	Sig 220/225/226/228/229 with or without Rails	Gunmetal Grey	06
413507BK-R	Springfield XD Compact and Service 4" Barrels	Gunmetal Grey	07
413509BK-R	H&K USP Compact	Gunmetal Grey	09
413510BK-R or L	S&W 5900/4000 9/.40 Series Incl. TSW	Gunmetal Grey	10
413513BK-R or L	Glock 20/21/37, S&W M&P .45 and 9/.40 Pro	Gunmetal Grey	13
413514BK-R or L	H&K USP Full Size 9/.40	Gunmetal Grey	14
413518BK-R or L	FN 5.7 USG MKI/MKII	Gunmetal Grey	18
413520BK-R or L	S&W J-Frame Revolvers 2" (Not .357)	Gunmetal Grey	20
413525BK-R or L	S&W M&P 9/.40 and Sigma	Gunmetal Grey	25



STANDARD CQC® HOLSTER



- Pressure adjustable detent retention system grabs onto the pistol's trigger guard and holds tight
- Available in matte finish only
- Includes SERPA® belt loop and paddle platform

Part Number	Model	Color	Size
415600BK-R or L	Glock 17/22/31	Black	00
415601BK-R	Glock 26/27/33	Black	01
415602BK-R or L	Glock 19/23/32/36	Black	02
415603BK-R	Gov't 1911 and Clones with or without rail	Black	03
415604BK-R	Beretta 92/96/M9 STD or A1 with rail (not Elite/Brig)	Black	04
415605BK-R	Sig 228/229 with or without rail	Black	05
415606BK-R	Sig 220/225/226 with or without rail	Black	06
415607BK-R	Springfield XD 4" and XDM 3.8"	Black	07
415609BK-R	H&K USP Compact	Black	09
415613BK-R	Glock 20/21	Black	13
415625BK-R	S&W M&P 9/.40, SD 9/.40 and Sigma	Black	25
415641BK-R	Ruger SR9/9E/SR40	Black	41
415642BK-R	Colt 1911 Commander	Black	42
415645BK-R	S&W M&P .45 and 9/40 Pro	Black	45
415649BK-R	Ruger LC9	Black	49
415663BK-R or L	S&W M&P Shield,	Black	63



- OMNIVORE™ Holsters fit more than 200 styles of semi-automatic handguns with an accessory rail
- Ergonomic thumb-activated retention mechanism delivers instant firearm access
- Uses two features to hold handgun securely in place
- Holster locks onto Rail Attachment Device (Non-LB) or frame of the light and doesn't wear on firearm's frame and finish

OMNIVORE™ NON-LIGHT BEARING

Part Number	Color	Fit
419000BUL	Black/Grey	Non-Light Bearing
419000BUR	Black/Grey	Non-Light Bearing
419000BCL	Black/Tan	Non-Light Bearing
419000BCR	Black/Tan	Non-Light Bearing
419000BBR	Black	Non-Light Bearing
419000BBL	Black	Non-Light Bearing



OMNIVORE™ SUREFIRE X300U-A/B

Part Number	Color	Fit
419001BUL	Black/Grey	Surefire X300U-A/B
419001BUR	Black/Grey	Surefire X300U-A/B
419001BCL	Black/Tan	Surefire X300U-A/B
419001BCR	Black/Tan	Surefire X300U-A/B
419001BBR	Black	Surefire X300U-A/B
419001BBL	Black	Surefire X300U-A/B



OMNIVORE™ STREAMLIGHT TLR-1/2

Part Number	Color	Fit
419002BUL	Black/Grey	Streamlight TLR-1/2
419002BUR	Black/Grey	Streamlight TLR-1/2
419002BCL	Black/Tan	Streamlight TLR-1/2
419002BCR	Black/Tan	Streamlight TLR-1/2
419002BBR	Black	Streamlight TLR-1/2
419002BBL	Black	Streamlight TLR-1/2



KYDEX IWB AND IWB/OWB HOLSTERS

- Pliable Kydex construction and flexible backing on IWB/OWB and OWB models for ultimate comfort
- Available in three configurations, including combination IWB/OWB
- Belt mount on IWB and IWB/OWB moves to fit user preference
- Designed to maximize concealability and comfort

INSIDE WAIST BAND-BLACK-LEFT OR RIGHT HAND

Part Number	Fit	Color
481468BKL or R	Glock 43/Kahr, P9/40, K9/40,PW/CW 9/40, CM/PM 9/40	Black
481402BKL or R	Glock, 19/23/26/27/32/33	Black
481425BKL or R	S&W M&P 4", & Cmpt 9/40 not 2.0 mod	Black
481463BKL or R	S&W M&P, Shield 9/40	Black
481434BKL or R	Sig 238	Black
481461BKL or R	Sig 320, Fullsize & Compact	Black



INSIDE OR OUTSIDE WAIST BAND-BLACK-LEFT OR RIGHT HAND

Part Number	Fit	Color
482068BKL or R	Glock 43/Kahr, P9/40, K9/40,PW/CW 9/40, CM/PM 9/40	Black
482002BKL or R	Glock, 19/23/26/27	Black
482025BKL or R	S&W M&P, Fullsize and Compact	Black
482063BKL or R	S&W M&P, Shield 9/40	Black
482034BKL or R	Sig 238	Black
482061BKL or R	Sig 320, Fullsize/Compact	Black



OUTSIDE WAIST BAND-BLACK-LEFT OR RIGHT HAND

Part Number	Fit	Color
480000BKL or R	Glock, 17/22/31	Black
480002BKL or R	Glock, 19/23/26/27	Black
480025BKL or R	S&W M&P, Full & Compact 9/40	Black

A.R.C. IWB HOLSTERS



- Soft, durable injection-molded material designed for comfort
- Fully ambidextrous design allows for left- and right-handed use
- Designed for both civilian and law enforcement concealed carry
- Packaged with two cant and ride height adjustment belt clips for 1.5" and 1.75" belts
- Allows for use of rear-mounted red dot sights

Part Number	Fit	Part	Color	Color
417500UG	Glock 17/22/31	00	Ambi	Urban Grey
417502UG	Glock 19/23/32	02	Ambi	Urban Grey
417563UG	S&W M&P Shield (9/40 only)	63	Ambi	Urban Grey
417567UG	Glock 42	67	Ambi	Urban Grey
417507UG	Springfield XD/Mod2/XDM	07	Ambi	Urban Grey
417520UG	S&W J-Frame 5-Shot 2" Revolver	20	Ambi	Urban Grey
417525UG	S&W M&P 22/9/40/45 (45-Compact only)	25	Ambi	Urban Grey
417549UG	Ruger LC380/LC9	49	Ambi	Urban Grey
417565UG	Springfield XDS 3.3/4.0	65	Ambi	Urban Grey
417568UG	Glock 43	68	Ambi	Urban Grey



TACTICAL HOLSTERS

SERPA® LEVEL 2 TACTICAL HOLSTER



- SERPA® Auto Lock™ release
- Passive retention detent adjustment screw
- Full-length holster body protects rear sights
- Flexible thigh platform conforms to leg size
- Y-harness suspension system distributes weight evenly, keeps holster vertical and allows use of pocket
- Quick-disconnect swivel buckles for quick holster mounting/dismounting
- Accessory mounting points for pouches, knives, mag cases, etc.
- Hole in holster body for optional bungee retention
- Rubberized leg straps eliminate sliding
- Fits all Blackhawk injection-molded platforms



MATTE FINISH

Part Number	Fit	Color	Size	NSN#
430500BK-R	Glock 17/19/22/23/31/32	Black	00	1095-01-533-3013
430500BK-L	Glock 17/19/20/21/22/31/32 and S&W M&P 9/.40/.45 (Not 2.0)	Black	00	
430503BK-R or L	Gov't 1911 and some Clones with or without Rails	Black	03	
430503CT-R or L	Gov't 1911 and some Clones with or without Rails t	Coyote Tan	03	1095-01-599-5853 (R)
430503OD-R or L	Gov't 1911 and some Clones with or without Rails	Olive Drab	03	
430504BK-R or L	Beretta 92/92A1/96/96A1/M9/M9A1 (not Brig./Elite)	Black	04	1095-01-533-3010
430504CT-R or L	Beretta 92/92A1/96/96A1/M9/M9A1 (not Brig./Elite)	Coyote Tan	04	1095-01-533-3009 (R)
430504CT-R or L-USMC	Beretta 92/92A1/96/96A1/M9/M9A1 with USMC Medallion (not Brig./Elite)	Coyote Tan	04	
430504FG-R or L	Beretta 92/92A1/96/96A1/M9/M9A1 (not Brig./Elite)	Foliage Green	04	
430504FG-R or L-Army	Beretta 92/92A1/96/96A1/M9/M9A1 with USMC Medallion(not Brig./Elite)	Foliage Green	04	
430504OD-R or L	Beretta 92/92A1/96/96A1/M9/M9A1 (not Brig./Elite)	Olive Drab	04	
430506BK-R or L	Sig 220/225/226/228/229 with or without Rails	Black	06	
430506CT-R or L	Sig 220/225/226/228/229 with or without Rails	Coyote Tan	06	1095-01-582-8118 (R)
430506OD-R or L	Sig 220/225/226/228/229 with or without Rails	Olive Drab	06	
430508BK-R or L	Sig Pro 2022	Black	08	
430513BK-R	Glock 20/21/21SF/37/38 and S&W M&P (All Models) with or without Rails	Black	13	
430526BK-R	Glock 21SF with Larger 1913 Rails	Black	26	

SERPA® LEVEL 3 TACTICAL HOLSTER



- SERPA® Auto Lock™ release
- Passive retention detent adjustment screw
- Thumb-activated Pivot Guard for additional security
- Full-length holster body protects rear sights
- Flexible thigh platform conforms to leg size
- Y-harness suspension system distributes weight evenly, keeps holster vertical and allows use of pocket
- Quick-disconnect swivel buckles for quick holster mounting/dismounting
- Accessory mounting points for pouches, knives, mag cases, etc.
- Rubberized leg straps eliminate sliding



MATTE FINISH

Part Number	Fit	Color	Size	NSN#
430600BK-R or L	Glock 17/19/22/23/31/32	Black	00	
430603BK-R or L	Gov't 1911 and some Clones with or without Rails	Black	03	
430604BK-R or L	Beretta 92/96/M9/M9A1 (Not For Brig./Elite/92A1/96A1)	Black	04	1095-01-599-0391 (R), 1095-01-599-0392 (L)
430604FG-R or L	Beretta 92/96/M9/M9A1 (Not For Brig./Elite/92A1/96A1)	Foliage	04	8465-01-623-7273 (R)
430606BK-R or L	Sig 220/225/226/228/229 with or without Rails	Black	06	
430607BK-R or L	Springfield XD/XDM	Black	07	
430608BK-R or L	Sig Pro 2022	Black	08	
430609BK-R or L	H&K USP Compact/P2000 (Euro)	Black	09	
430610BK-R or L	S&W 5946	Black	10	
430614BK-R or L	H&K USP Full Size 9/.40	Black	14	
430616BK-R or L	H&K P2000 (US)	Black	16	
430617BK-R or L	H&K P30	Black	17	
430624BK-R	Walther P99, S&W SW99	Black	24	
430625BK-R or L	S&W M&P 9/.40 with or without Thumb Safety (Not 2.0)	Black	25	
430645BK-R or L	S&W M&P .45 and 9/.40 Pro with or without Thumb Safety (Not 2.0)	Black	45	

MILITARY SERPA® COMBO KIT



- SERPA® Level 2 Tactical Holster
- Drop leg platform
- SERPA® Jacket Slot Belt Loop
- S.T.R.I.K.E.® Plate
- Quick-Disconnect kit



PLAIN FINISH

Part Number	Fit	Color
4305USACT-R or L	Beretta 92/96/M9/M9A1	Coyote Tan

PLATFORMS/ACCESSORIES

QUICK DISCONNECT SYSTEM KIT



- Allows one holster to be used on multiple platforms and easy 360-degree adjustments
- Kit includes two Female Adapters and one Male Adapter
- Holster releases by lifting the quick-disconnect tabs and turning counterclockwise

Part Number	Description	Color
430950BK	Quick Disconnect System Kit	Black
430950CT	Quick Disconnect System Kit	Coyote Tan
430950FG	Quick Disconnect System Kit	Forest Green
430950OD	Quick Disconnect System Kit	Olive Drab
430951BK	Quick Disconnect Male Adapter	Black
430951CT	Quick Disconnect Male Adapter	Coyote Tan
430951FG	Quick Disconnect Male Adapter	Forest Green
430951OD	Quick Disconnect Male Adapter	Olive Drab
430952BK	Quick Disconnect Female Adapter	Black
430952CT	Quick Disconnect Female Adapter	Coyote Tan
430952FG	Quick Disconnect Female Adapter	Forest Green
430952OD	Quick Disconnect Female Adapter	Olive Drab



TACTICAL HOLSTER PLATFORM



- Flexible thigh platform conforms to leg size
- Y-harness suspension system distributes weight evenly, keeps holster vertical and allows use of pocket
- Quick-disconnect swivel buckles for quick holster mounting/dismounting
- Rubberized leg straps eliminate sliding
- Accessory mounting points for pouches, knives, mag cases, etc.
- Requires Duty Accessory Mounting Screw Kit (sold separately) for mounting Blackhawk duty gear
- Accommodates Blackhawk Injection-molded concealment or duty holsters

Part Number	Description	Color	NSN#
432000PBK	Tactical Holster Platform	Black	
432000PCT	Tactical Holster Platform	Coyote Tan	8465-01-529-7439
432000PFG	Tactical Holster Platform	Forest Green	
432000POD	Tactical Holster Platform	Olive Drab	8465-01-529-7440



SHOULDER HARNESS HOLSTER PLATFORM



Holster not included

- Tapered, fully adjustable web harness and an offside dual Picatinny rail platform for accessories
- Mount Blackhawk injection-molded concealment holsters to underarm platform in horizontal position
- Enables one-handed re-holstering (right or left hand)
- Medium (41SH00) fits shirt size Medium to XL and Large (41SH01) fits shirt size XL to 3XL

Part Number	Description	Color	Size	NSN#
41SH00BK-R	Shoulder Harness Holster Platform	Black	Medium	
41SH00BK-L	Shoulder Harness Holster Platform	Black	Large	8465-01-613-1279 (R)
41SH01BK-R	Shoulder Harness Holster Platform	Black	Large	8465-01-613-1279 (R)
41SH01BK-L	Shoulder Harness Holster Platform	Black	Large	8465-01-613-1279 (R)

S.T.R.I.K.E.® PLATFORM



- Ambidextrous adapter platform
- Constructed of injection-molded polymer carbon-fiber blend
- Designed to fit any Blackhawk injection-molded holster at any angle
- Holds rail-mounted accessories such as mag cases, light cases, knife sheaths, etc.
- Can be mounted to any S.T.R.I.K.E.® or PALS/MOLLE platform
- Does not include holster



Part Number	Description	Color	NSN#
38CL63BK	S.T.R.I.K.E. Platform	Black	8465-01-613-1607
38CL63CT	S.T.R.I.K.E. Platform	Coyote Tan	8465-01-555-1506
38CL63FG	S.T.R.I.K.E. Platform	Forest Green	
38CL63OD	S.T.R.I.K.E. Platform	Olive Drab	8465-01-599-8401

S.T.R.I.K.E.® PLATFORM WITH SERPA® HOLSTER (BERETTA ONLY)



- Ambidextrous adapter platform
- Designed to fit SERPA® CQC® Concealment Holster at any angle
- For Beretta M9/92/96 (not Elite, Brigadier or M9A1)
- Can be mounted to any S.T.R.I.K.E.® or PALS/MOLLE platform
- Holster included



Part Number	Description	Color	NSN#
40CL01FG-R	S.T.R.I.K.E. Platform with SERPA Holster	Forest Green	
40CL01FG-L	S.T.R.I.K.E. Platform with SERPA Holster	Forest Green	
40CL01CT-R or L	S.T.R.I.K.E. Platform with SERPA Holster	Coyote Tan	1095-01-533-3014 (R), 1095-01-533-3012 (L)

HOLSTER SPACER KIT



- Adjust the angle or distance away from the body of any Blackhawk injection-molded holster
- Concealment Holster Spacer Kit (411400C) includes two spacers and 8-32 screws
- Tactical/Duty Holster Spacer Kit (411401C) includes one spacer and 10-32 screws

Part Number	Description	Color
411400CBK	Concealment Holster Spacer Kit	Black
411401CBK	Tactical/Duty Holster Spacer Kit	Black



SERPA® S.T.R.I.K.E.® COMBO KIT (BERETTA ONLY)



- Designed to fit SERPA® CQC® Concealment Holster Beretta M9/92/96 (not Elite, Brigadier or M9A1)
- Includes Tactical Holster Platform
- Includes S.T.R.I.K.E.® Platform with SERPA® Holster
- Includes Belt Loop Platform
- Includes Shoulder Harness Holster Platform (black only)
- Medium (40SC02) fits shirt size Medium to XL
- Large (40SC03) fits shirt size XL to 3XL

Part Number	Description	Color	Size
40SC02CT-R or L	SERPA S.T.R.I.K.E. Combo Kit	Coyote Tan	Medium
40SC02FG-R or L	SERPA S.T.R.I.K.E. Combo Kit	Forest Green	Medium
40SC03CT-R or L	SERPA S.T.R.I.K.E. Combo Kit	Coyote Tan	Large



PADDLE PLATFORM WITH SCREWS



- Designed to fit any Blackhawk injection-molded concealment holster

Part Number	Description	Color
410902BK	Paddle Platform	Black



BELT LOOP PLATFORM WITH SCREWS



- Designed to fit any Blackhawk injection-molded concealment holster

Part Number	Description	Color	NSN#
410901BK	Belt Loop Platform	Black	8465-01-599-8921



HIGH-RIDE DUTY BELT LOOP WITH SCREWS



- Designed to fit any Blackhawk injection-molded duty holster
- Moves holster higher on duty belt
- Fits 2" and 2.25" duty belts

Part Number	Description	Color
44H900BK	High-Ride Duty Belt Loop with Screws	Black



SERPA® JACKET SLOT DUTY BELT LOOP WITH SCREWS



- Designed to fit any Blackhawk injection-molded duty holster
- Attach holster to duty belt without unthreading other gear
- Fits 2" and 2.25" duty belts

Part Number	Description	Color
44H901BK	SERPA® Jacket Slot Duty Belt	Black



MID-RIDE DUTY BELT LOOP WITH SCREWS



- Designed to fit any Blackhawk injection-molded duty holster
- Moves holster higher on duty belt
- Fits 2" and 2.25" duty belts

Part Number	Description	Color
44H902BK	Mid-Ride Duty Belt Loop	Black



QUICK DUAL RELEASE BELT LOOP

- Designed to fit any Blackhawk injection molded holster
- Both release buttons must be activated for removal
- Meets our rigid strength requirements for law enforcement duty use

Part Number	Fit	Color
44H909BK	Quick Dual Release Belt Mount	Black



T-SERIES® JACKET SLOT BELT LOOP

- Designed to fit any Blackhawk injection-molded holster
- Thumb channel for improved clearance and use with gloved hands
- Compatible with single leg strap attachments
- Fits up to 2.25" duty belts

Part Number	Fit	Color
44H908BK	T-Series Jacket Slot Belt Loop	Black



2-SLOT BELT LOOP

- Designed to fit any Blackhawk injection molded holster
- Ambidextrous
- Cant adjustable for angle of draw
- Asymmetrical design tucks grip of handgun toward body for improved concealment

Part Number	Fit	Color
44H910BK	2-Slot Belt Loop	Black



NYLON VERTICAL SHOULDER HOLSTER



- Constructed of 1000 denier CORDURA® nylon outer material
- CORDURA® nylon outer shell and waterproof closed-cell foam padding
- Offside tie-down with dual Picatinny rail platform for accessories
- Adjustable, non-stretch retention strap with molded finger break
- Fits handguns without scopes (40VH)



WITHOUT SCOPE

Part Number	Description	Color	Size
40VH00BK-R or L	2" – 3" Barrel Small/Medium Double-Action Revolvers (Except 2" 5-Shot)	Black	00
40VH01BK-R or L	3" – 4" Barrel Medium Autos and 3.25" – 3.75" Barrel Large Autos (.32/.380)	Black	01
40VH02BK-R or L	4" Barrel Medium/Large Double-Action Revolvers	Black	02
40VH03BK-R or L	5" – 6.5" Barrel Medium/Large Double-Action Revolvers and 4.625" – 5.25" Barrel Single-Action Revolvers	Black	03
40VH04BK-R or L	7" – 8.5" Barrel Medium/Large Double-Action Revolvers and 6" – 7.5" Barrel Single-Action Revolvers	Black	04
40VH05BK-R or L	4.5" – 5" Barrel Large Autos, Open End (Safety Strap Rotates to Secure Autos on Grip or Hammer)	Black	05
40VH06BK-R or L	5.5" – 6" Barrel .22 Autos and Airguns	Black	06
40VH11BK-R or L	9.5" – 10.75" Barrel Single- and Double-Action Revolvers	Black	11
40VH12BK-R or L	10" Barrel T/C Contenders	Black	12
40VH13BK-R or L	14" and 16" Barrel T/C Super Contenders, Encore and 10" Barrel Remington XP-100	Black	13
40VH15BK-R or L	3.75" – 4.5" Barrel Large Autos	Black	15

NYLON HORIZONTAL SHOULDER HOLSTER

- Constructed of 1000 denier CORDURA® nylon outer material
- Offside plate for optional accessories
- Non-stretch retention strap with molded thumb break



Part Number	Description	Color	Size
40HS05BK MD or LG	4.5" – 5" Barrel Large Autos	Black	05
40HS15BK MD or LG	3.75" – 4.5" Barrel Large Autos	Black	15
40HS36BK MD or LG	2" Barrel Small-Frame 5-Shot Revolvers with Hammer Spur	Black	36



NYLON UNIVERSAL SPEC OPS PISTOL HARNESS

- For cross-body in the vertical, horizontal or angled position
- Constructed of 1000 denier CORDURA® nylon outer material
- Padded and fully adjustable
- Fits most semi-auto pistols
- Right-hand model only

Part Number	Description	Color
40SH04BK	Nylon Universal Spec Ops Pistol Harness	Black



NYLON 3-SLOT PANCAKE HOLSTER

- Gives the option of strong-side, kidney or crossdraw mounting options
- A reversible/adjustable retention strap with molded thumb break provides reliable weapon security
- Ambidextrous design
- Constructed of 1000 denier CORDURA® nylon outer material
- Lined with smooth, snag-resistant material
- Belt slots pull holster body close for maximum concealment
- Fits belts up to 1.75" wide



Part Number	Description	Color	Size
40PC00BK	2" - 3" Barrel Small/Medium Double-Action Revolvers (Except 2" 5-Shot)	Black	00
40PC01BK	3" - 4" Barrel Medium-Frame .32/.380 Autos	Black	01
40PC02BK	4" Barrel Medium and Intermediate Double-Action Revolvers	Black	02
40PC03BK	4.5" - 5" Barrel Large Autos	Black	03
40PC04BK	Glock 26/27/33 and other Sub-Compact 9/.40	Black	04
40PC05BK	3.75" - 4.5" Barrel Large Autos	Black	05
40PC06BK	3.25" - 3.75" Barrel Medium/Large Autos	Black	06
40PC36BK	2" Barrel Small-Frame 5-Shot Revolvers with Hammer Spur	Black	36

NYLON TASER® C2 HOLSTER

- Constructed of 1000 denier CORDURA® nylon outer material with 1/8" padding
- Retention strap with snap thumb break
- Molded belt loop
- Weight: 1.6 oz.
- Fits Civilian TASER® C2



Part Number	Description	Color
40C200BK	TASER® C2	Black

NYLON LASER HOLSTER



- Carries popular-sized pistols with most under-barrel laser systems
- Constructed of 1000 denier CORDURA® nylon outer material
- Right hand only

Part Number	Description	Color	Size
40LH01BK	3" – 4" BBL Medium Autos with Most Under-Barrel Lasers	Black	01
40LH02BK	3.25" – 3.75" BBL Medium/Large-Frame Autos with Most Under-Barrel Lasers	Black	02
40LH03BK	Gov't 1911 with Most Under-Barrel Lasers	Black	03



NYLON HIP HOLSTER



- Constructed of 1000 denier CORDURA® nylon outer material
- Smooth nylon lining for easy draw
- Adjustable retention strap with non-glare snaps

Part Number	Description	Color	Size
73NH00BK-R or L	2" – 3" Barrel Small/Medium Double-Action Revolvers (Except 2" 5-Shot)	Black	00
73NH01BK-R or L	3" – 4" Barrel Medium .32/.380 Frame .32/.380 Autos	Black	01
73NH02BK-R or L	3" – 4" Barrel Medium/Large Double-Action Revolvers	Black	02
73NH03BK-R or L	5" – 6.5" Barrel Medium/Large Double-Action Revolvers	Black	03
73NH04BK-R or L	4.5" – 5" Barrel Large Autos, Open End	Black	04
73NH05BK-R or L	Small Autos (.22/.25) and Very Small-Frame .32 and .380s	Black	05
73NH06BK-R or L	Glock 26/27/33 and other Sub-Compact 9/.40	Black	06
73NH07BK-R or L	3.5" – 4.5" Barrel Large Autos, Open End	Black	07
73NH08BK-R or L	3.25" – 3.75" Barrel Medium/Large Autos	Black	08
73NH09BK-R or L	2" Small-Frame 5-Shot Revolvers with Hammer Spur	Black	09
73NH10BK-R or L	7" – 8.5" Barrel Medium/Large Double-Action Revolvers (Tie-Down Loop Included)	Black	10
73NH11BK-R or L	9.5" – 10.75" Barrel Single- and Double-Action Revolvers (Tie-Down Loop Included)	Black	11
73NH12BK-R or L	3" – 5" Barrel Single-Action Revolvers	Black	12
73NH13BK-R or L	5.5" – 6.5" Barrel Single-Action Revolvers	Black	13
73NH15BK-R or L	6.5" – 7.5" Barrel Single-Action Revolvers	Black	15
73NH16BK-R or L	5.5" – 6" Barrel .22 Autos and Airguns	Black	16



INSIDE-THE-PANTS HOLSTER



- Constructed of soft laminate suede-like outer material
- Smooth nylon lining for easy draw
- Belt clip slips over pants or belt to retain holster
- Fold-over hook & loop retention strap (73IR0 only)

Part Number	Description	Color	Size
73IP00BK	2" – 3" Barrel Small/Medium Double-Action Revolvers (Except 2" 5-Shot)	Black	00
73IP00BK-L	2" – 3" Barrel Small/Medium Double-Action Revolvers (Except 2" 5-Shot)	Black	00
73IP01BK	3" – 4" Barrel Medium-Frame .32/.380 Autos	Black	01
73IP01BK-L	3" – 4" Barrel Medium-Frame .32/.380 Autos	Black	01
73IP02BK	4" Barrel Medium and Intermediate Double-Action Revolvers	Black	02
73IP02BK-L	4" Barrel Medium and Intermediate Double-Action Revolvers	Black	02
73IP03BK	4.5" – 5" Barrel Large Autos	Black	03
73IP03BK-L	4.5" – 5" Barrel Large Autos	Black	03
73IP04BK	Small Autos (.22/.25) and Very Small-Frame .32 and .380s	Black	04
73IP04BK-L	Small Autos (.22/.25) and Very Small-Frame .32 and .380s	Black	04
73IP05BK	Glock 26/27/33 and other Sub-Compact 9/.40	Black	05
73IP05BK-L	Glock 26/27/33 and other Sub-Compact 9/.40	Black	05
73IP06BK	3.75" – 4.5" Barrel Large Autos	Black	06
73IP06BK-L	3.75" – 4.5" Barrel Large Autos	Black	06
73IP07BK	3.25" – 3.75" Barrel Medium/Large Autos	Black	07
73IP07BK-L	3.25" – 3.75" Barrel Medium/Large Autos	Black	07
73IP08BK	2" Barrel Small-Frame 5-Shot Revolvers, Small-Frame .380s with Crimson Trace		08
73IP08BK-L	2" Barrel Small-Frame 5-Shot Revolvers, Small-Frame .380s with Crimson Trace		08
With Retention Strap			
73IR00BK-R or L	2" – 3" Barrel Small/Medium Double-Action Revolvers (Except 2" 5-Shot)		00
73IR01BK-R or L	3" – 4" Barrel Medium-Frame .32/.380 Autos		01
73IR02BK-R	4" Barrel Medium and Intermediate Double-Action Revolvers		02
73IR03BK-R or L	4.5" – 5" Barrel Large Autos		03
73IR04BK-R	Small Autos (.22/.25) and Very Small-Frame .32 and .380s		04
73IR06BK-R or L	3.75" – 4.5" Barrel Large Autos		06
73IR07BK-R or L	3.25" – 3.75" Barrel Medium/Large Autos		07
73IR08BK-R or L	2" Barrel Small-Frame 5-Shot Revolvers, Small-Frame .380s with Crimson Trace		08



TECGRIP® IWB HOLSTERS



- Designed for both civilian and law enforcement concealed carry
- Proprietary gripping material allows for clipless inside-the-waistband carry
- Fully ambidextrous design for left- and right-handed use
- Washable with soap and water; air dry

Part Number	Description	Size
40IP00CT or BK	2" – 3" Barrel Small/Medium Double-Action Revolvers (Except 2" 5-Shot)	00
40IP01CT or BK	3" – 4" Barrel Medium-Frame .32/.380 Autos	01
40IP02CT or BK	4" Barrel Medium and Intermediate Double-Action Revolvers	02
40IP03CT or BK	4.5" – 5" Barrel Large Autos	03
40IP04CT or BK	Small Autos (.22/.25) and Very Small-Frame .32 and .380s	04
40IP05CT or BK	Glock 26/27/33 and other Sub-Compact 9/.40	05
40IP06CT or BK	3.75" – 4.5" Barrel Large Autos	06
40IP07CT or BK	3.25" – 3.75" Barrel Medium/Large Autos	07
40IP08CT or BK	2" Barrel Small-Frame 5-Shot Revolvers, Small-Frame .380s with Crimson Trace	08



TECGRIP® POCKET HOLSTERS



- Designed for both civilian and law enforcement concealed carry
- Proprietary gripping material secures holster in any pocket
- Ambidextrous design for left- and right-handed use
- Washable with soap and water; air dry

Part Number	Description	Size
40TP01CT or BK	Small Autos (.22/.25)	01
40TP02CT or BK	Most Small-Frame .380s	02
40TP03CT or BK	2" 5-Shot Ruger, Kel-Tec, Kahr and Taurus .380	03
40TP04CT or BK	Most Sub-Compact 9/.40 Autos	04



TECGRIP® MAG POUCHES



- Proprietary gripping material secures magazine in any pocket
- Ambidextrous design for left- and right-handed use
- Washable with soap and water; air dry

Part Number	Description
40MP01CT	Single Stack Full Size & Compact
40MP02CT	Double Stack Full Size & Compact



Single Stack

Double Stack

TECGRIP® JUNK DRAWER



- Designed to carry in the appendix position with an extra magazine, the TecGrip material allows the holster to stay in place for all day wear and comfort
- Allows for left or right usage and the ability to tailor the carry to your desired location.
- The thermal bonded construction process binds the material together for strength and durability.



Part Number	Fit	Color	Size
40JD04BK	Glock 42/Ruger LCP II/Micro 380S & Very Small frame .32/.380	Black	04
40JD05BK	Glock 43/43X/Shield 9/.40/.45/Hellcat/LC9 & Small Frame 9/.40	Black	05
40JD06BK	Glock 19/26/27/M&P 9C/Taurus G2 & other 3.75"-4.5" Barrel Autos	Black	06

NYLON ANKLE HOLSTER



- Constructed of 1000 denier CORDURA® nylon outer material
- Closed-cell foam padding protects pistol from moisture
- Non-stretch retention strap with molded thumb break



Part Number	Description	Color	Size
40AH00BK-R or L	2" Barrel Small-Frame 5-Shot Revolvers with Hammer Spur	Black	00
40AH01BK-R or L	3" – 4" Barrel Medium-Frame .32/.380 Autos	Black	01
40AH10BK-R or L	Small Autos (.22/.25) and Very Small-Frame .32 and .380s	Black	10
40AH12BK-R or L	Glock 26/27/33 and other Sub-Compact 9/.40	Black	12
40AH16BK-R or L	3.25" - 3.75" Barrel Medium/Large Autos	Black	16

NYLON AMBIDEXTROUS MULTI-USE HOLSTER



- Constructed of 1000 denier CORDURA® nylon outer material
- Removable spring-steel clip
- Reversible, non-stretch hook & loop retention strap with molded thumb break
- Fits belts up to 1.75" wide in a traditional vertical position
- Fits belts up to 1.5" wide in horizontal position (middle of the back)
- Holsters for semi-auto pistols include spare mag pouch with adjustable retention flap



Part Number	Description	Color	Size
40AM01BK	3" – 4" Barrel Medium-Frame .32/.380 Autos	Black	01
40AM02BK	4" Barrel Medium/Large Double-Action Revolvers	Black	02
40AM03BK	4.5" – 5" Barrel Large Autos	Black	03
40AM05BK	3.75" – 4.5" Barrel Large Autos	Black	05
40AM06BK	3.25" - 3.75" Barrel Medium/Large Autos	Black	06
40AM36BK	2" – 2.25" Small-Frame 5- and 6-Shot Revolvers with Hammer Spur	Black	36

NYLON BELT POUCH HOLSTER



- Constructed of 1000 denier CORDURA® nylon outer material
- Top zipper opening can remain open or closed without revealing weapon
- Discreet hook & loop flap inside pouch keeps handgun hidden
- Separate pocket on front of pouch holds keys, cuffs, camera, company patch or other items
- Dual belt loops fit belts up to 2" wide
- Mini model (40BP00) fits 2" 5-shot revolvers and sub-compact autos
- Large model (40BP01) fits 3" revolvers and medium- and large-frame semi-autos



Part Number	Description	Color
40BP00BK	Mini	Black
40BP01BK	Large	Black

NYLON AMBIDEXTROUS FLAT BELT HOLSTER

- Ambidextrous design
- Constructed of 1000 denier CORDURA® nylon outer material
- Fits belts up to 2" wide
- Adjustable, reversible thumb break
- Fits most small- to medium-frame and medium- to large-frame semi-autos and revolvers



Part Number	Description	Color
40FB02BK	Nylon ambidextrous flat belt holster	Black

NYLON CONCEALED WEAPON FANNY PACK HOLSTER

- Constructed of 1000 denier CORDURA® nylon outer material
- Retention belt loops attach to belt for extra security and retention
- Universal design fits most small- to medium-frame and medium- to large-frame semi-autos and revolvers



Part Number	Description	Color	NSN#
60WF04BK	Small	Black	
60WF05BK	Medium	Black	
60WF06BK	Large	Black	8465-01-535-1410

NYLON Ω MEGA[®] VI IMPROVED UNIVERSAL AMBIDEXTROUS DROP LEG HOLSTER

- Ambidextrous design
- Constructed of 500 denier CORDURA[®] nylon
- Designed primarily for law enforcement officers
- Y-harness drop leg platform for even weight distribution
- Elastic, rubberized leg straps for stability and comfort
- Adjustable thumb break with retention strap for secure fit
- Fits most pistols with or without light or laser aiming module



Part Number	Description	Color
40ALH1BK	Nylon Ω mega VI Improved Drop Leg	Black

NYLON Ω MEGA[®] VI ULTRA

- For wear on a belt or any S.T.R.I.K.E.[®] or PALS/MOLLE platform
- Ambidextrous design
- Constructed of 1000 denier CORDURA[®] nylon outer material
- Elastic, rubberized leg straps for stability and comfort
- Includes Speed Clips[™] and three side-release buckles for three-point breakaway
- Front-mounted pouch for extra magazine, knife or light
- Adjustable thumb break with extra hook & loop retention
- Fits most pistols with or without light or laser aiming module



Part Number	Description	Color
40MLH1BK	Nylon Ω mega VI Ultra	Black
40MLH1CT	Nylon Ω mega VI Ultra	Coyote Tan
40MLH1OD	Nylon Ω mega VI Ultra	Olive Drab
40MLH1AU	Nylon Ω mega VI Ultra	Army Specific

NYLON Ω MEGA[®] VI ELITE HOLSTER

- Constructed of 1000 denier CORDURA[®] nylon outer material
- Elastic, rubberized leg straps for stability and comfort
- Three side-release buckles for three-point breakaway
- Front-mounted pouch for extra magazine, knife or light
- Removable retention strap
- Adjustable thumb break with extra hook & loop retention



Part Number	Description	Color	Size
40QD02BK-R or L	Glock 17/19/22/23/27/31/32 and Sig 226/228	Black	02
40QD22BK-R or L	Colt 1911 45 and Browning Hi-Power	Black	22

SINGLE MAG CASES



- Features a built-in tension spring to securely hold magazines of various sizes
- Remove the belt clip and place two Single Mag Cases side-by-side on Dual Rail Accessory Platform
- Single-stack versions fit 9mm/.40 cal/.45 cal/10mm/.357 Sig
- Double-stack versions fit 9mm/.40 cal

MATTE FINISH

Part Number	Description	Color
410500PBK	Single Stack	Black
410500PCT	Single Stack	Coyote Tan
410600PBK	Double Stack	Black
410600PCT	Double Stack	Coyote Tan
410600POD	Double Stack	Olive Drab



CARBON-FIBER FINISH

Part Number	Description	Color
410500CBK	Single Stack	Black
410600CBK	Double Stack	Black

DOUBLE MAG CASES



- Built-in tension spring securely holds magazines of various sizes
- Includes belt loops and belt clip
- Curved to waistline for slimmer profile
- Single-stack versions fit 9mm/.40 cal/.45 cal/10mm/.357 Sig

Part Number	Description	Color	Finish
410510CBK	Single Stack	Black	Carbon Fiber
410510PBK	Single Stack	Black	Matte
410610CBK	Double Stack	Black	Carbon Fiber
410610PBK	Double Stack	Black	Matte



QUICKMOD™ MAGAZINE CASES



- Rotating and locking quick-detach belt attachment
- Adjustable to belts 1.5 to 2.25" wide
- Positive lock indicator for added security

Part Number	Description	Color
411600BK	QuickMod Pistol Magazine Case	Black
411601BK	QuickMod AR-15 Magazine Case	Black



TACTICAL PISTOL LANYARD COILED



- Made with coiled wire and black rubber external laminate
- Attaches to belt with loop
- 90TPL1BK attaches to firearm with gutted 550 Cord (not included)
- 90TPL1BK attaches to firearm with snap hook and mini ring
- Allows full extension while shooting

Part Number	Description	Color	NSN#
90TPL1BK	Coiled (Non Swivel)	Black	
90TPL2BK	Coiled (Single Swivel/Snap Hook/Mini Ring)	Black	4020-01-514-8839

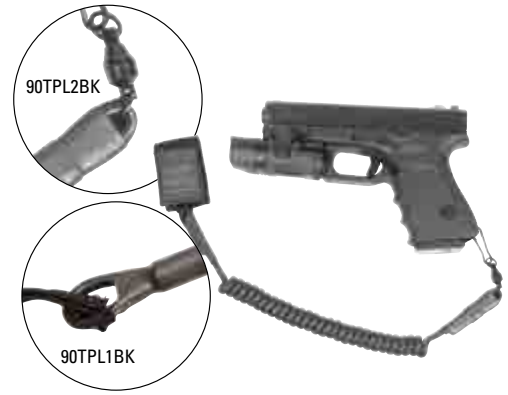

TASER® SIDE MOUNT PLATE



- Mounts the TASER® X26 Cartridge Holder to TASER® X26 Duty Holster and saves space
- Unique front side positioning allows for fast reloads
- Perfect for mounting on a crowded MOLLE vest
- Fits duty belts up to 2.25" wide
- Positions spare cartridge to outboard side of TASER® X26 Duty Holster (sold separately)
- Available in right- or left-hand models

Part Number	Description	Color
44H907BK-R or L	TASER® Side Mount Plate	Black



TASER® X26/X26P CARTRIDGE HOLDER



- Attaches easily to Blackhawk TASER® X26 Duty Holster
- Rapid reload capability
- Mini Mod-U-Lok™ belt loop with adjustable spacer fits most duty belts
- Ambidextrous design

Part Number	Description	Color
44A890BK	TASER® X26 Cartridge Holder	Black



DUAL RAIL™ ACCESSORY PLATFORM



- High-strength proprietary Polymer construction
- Designed for weapon-mounted Picatinny rail lights such as Streamlight® TLR-1/ TLR-2 family of lights
- Removable M-3 holder
- Available in paddle or belt loop models



Part Number	Description	Color
410800CBK	Dual Rail™ Accessory Platform Paddle Mount	Black
411300CBK	Dual Rail™ Accessory Platform Belt Loop	Black

COMPACT LIGHT CARRIER



- Designed to hold small, personal-sized lights such as Streamlight® Scorpion®, TL-2® or TL-3®
- Button recess at bottom prevents accidental light activation
- Built-in tension device provides secure light carry
- Removable belt clip
- Can be mounted to Blackhawk Dual Rail™ Accessory Platform (sold separately)



Part Number	Description	Color	Finish	NSN#
411000CBK	Compact Light Carrier	Black	Carbon Fiber	
411000PBK	Compact Light Carrier	Black	Matte	8465-01-529-5681
411000PCT	Compact Light Carrier	Coyote Tan	Matte	8465-01-529-5682

TACTICAL MAG POUCH



- High-strength proprietary polymer construction
- Molded flap with snap retains magazine
- Mounts directly to tactical holster platforms (sold separately)



Part Number	Description	Color	NSN#
430900BK	Tactical Mag Pouch	Black	
430900CT	Tactical Mag Pouch	Coyote Tan	8465-01-623-7274

DEMONSTRATOR REPLICA GUNS



- Exact size of real pistol
- Injection-molded, high-strength, glass-filled polymer

Part Number	Description	Color
44DG1911OR	Colt 1911	Orange
44DGGL17OR	Glock 17/22/31	Orange
44DG226ROR	Sig 226 with rail	Orange





**DUTY +
PROTECTIVE**

DYNAMIC ENTRY® ACTIVE SHOOTER HALLAGAN TOOL



- Features counter-angled friction ridges to grip breaching surfaces securely and increase bite
- Redesigned tempered stainless steel wedge and horn
- Ergonomic handle reinforces proper hand placement
- Non-sparking fork end
- Length: 24"
- Weight: 7.5 lbs.
- **SPECIAL NOTE: This Blackhawk product is restricted to Emergency Response Personnel, Military, Law Enforcement and Security Personnel ONLY**



Part Number	Description	Color
DE-ASHT	Active Shooter Hallagan Tool	Black

DYNAMIC ENTRY® MINI BREAK-N-RAKE™



- Designed in conjunction with domestic and international operators
- Can replace Special Operations Hallagan Tool in the Tactical Backpack Kit
- Easily fits in trunk of patrol or rescue vehicles
- Length: 25"
- Weight: 4.5 lbs.
- **SPECIAL NOTE: This Blackhawk product is restricted to Emergency Response Personnel, Military, Law Enforcement and Security Personnel**



Part Number	Description	Color
DE-MBR	Mini Break-N-Rake	Black

DYNAMIC ENTRY® BREAK-N-RAKE™



- Specifically engineered for window entries
- Military-grade steel serrated blade and laser-cut hook
- Three carbon steel 12" raking fins to clear away glass and other debris
- Reinforced hook removes curtains, blinds and other obstructions
- Length: 51" (DE-BR), 69" (DE-SBR)
- Weight: 9.6 lbs. (DE-BR), 11 lbs. (DE-SBR)
- **SPECIAL NOTE: This Blackhawk product is restricted to Emergency Response Personnel, Military, Law Enforcement and Security Personnel**



Part Number	Description	Color	NSN#
DE-BR	Break-N-Rake	Black	4210-01-583-8001
DE-SBR	Super Break-N-Rake	Black	

DYNAMIC ENTRY® MOBILE HOME DOOR BREACHER



- Designed for outward-opening mobile home doors
- Unique leverage orientation pulls locking mechanism free of doorjamb while opening door
- Reinforced, laser-cut carbon steel head
- Length: 28.5"
- Weight: 5.5 lbs.
- **SPECIAL NOTE: This Blackhawk product is restricted to Emergency Response Personnel, Military, Law Enforcement and Security Personnel ONLY**



Part Number	Description	Color
DE-MHB	Mobile Home Door Breacher	Black

DYNAMIC ENTRY® BREACHING SLEDGE



- Micro-metal composition for added strength and reduced spalling when struck
- Sure-grip handle system reduces the chance of slippage during operations
- Friction ridges on the wedge for added grip and stability during breaching
- Length: 22"
- Weight: 8 lbs.
- **SPECIAL NOTE: This Blackhawk product is restricted to Emergency Response Personnel, Military, Law Enforcement and Security Personnel ONLY**



Part Number	Description	Color	NSN#
DE-BS	Breaching Sledge	Black	5120-01-554-2827

DYNAMIC ENTRY® BREACHER SERIES



- Tempered stainless steel wedge with counter-angled friction ridges for tool stability and gripping
- Safety-guard handgrip reduces the possibility of operator's hands slipping onto working end of tool
- Length: 14.25" (Mini Breacher), 24" (Special Ops Breacher), 30" (Standard Breacher)
- Weight: 4.7 lbs. (Mini Breacher), 5.4 lbs. (Special Ops Breacher), 6 lbs. (Standard Breacher)
- **SPECIAL NOTE: This Blackhawk product is restricted to Emergency Response Personnel, Military, Law Enforcement and Security Personnel ONLY**

Part Number	Description	Color	NSN#
DE-MB	Mini Breacher	Black	
DE-SOB	Special Operations Breacher	Black	
DE-TB	Breacher	Black	5120-01-583-4403



DYNAMIC ENTRY® THUNDERSLEDGE™ SERIES



- Sure-grip handle system reduces slippage during operations
- Drop-forged, heat-treated carbon steel striking head
- Length: 14" (Micro), 22" (Mini) 32" (ThunderSledge)
- Weight: 4.6 lbs. (Micro), 7.5 lbs. (Mini), 12 lbs. (ThunderSledge)
- **SPECIAL NOTE: This Blackhawk product is restricted to Emergency Response Personnel, Military, Law Enforcement and Security Personnel ONLY**



Part Number	Description	Color	NSN#
DE-MCR	Micro ThunderSledge	Black	
DE-MTS	Mini ThunderSledge	Black	5120-01-554-2847
DE-MTSY	Mini ThunderSledge	Yellow	
DE-TS	ThunderSledge	Black	5120-01-554-2857

DYNAMIC ENTRY® THUNDERMAUL™



- Incorporates an axe and sledge into one compact tool for diverse entry function
- Sure-grip handle system reduces slippage during operations
- Drop-forged, heat-treated carbon steel striking head
- Nick-resistant tempered blade
- Length: 21.5"
- Weight: 7.5 lbs.
- **SPECIAL NOTE: This Blackhawk product is restricted to Emergency Response Personnel, Military, Law Enforcement and Security Personnel ONLY**



Part Number	Description	Color	NSN#
DE-TM	ThunderMaul	Black	4210-01-532-4603
DE-TMY	ThunderMaul	Yellow	

DYNAMIC ENTRY® DYNAMIC DUO™ KIT



- Includes Dynamic Entry® Breacher
- Includes Dynamic Entry® ThunderSledge™
- Includes Dynamic Entry® Dynamic Duo Quiver
- Length: 32"
- Weight: 18 lbs
- **SPECIAL NOTE: This Blackhawk product is restricted to Emergency Response Personnel, Military, Law Enforcement and Security Personnel ONLY**



Part Number	Description	Color
DE-DD	Dynamic Duo Kit	Black
DE-DDQ-USA	Dynamic Duo Quiver	Black

DYNAMIC ENTRY® U.K. HALLAGAN TOOL



- Unique glass-buster head for “break and rake” operations
- Safety-guard handgrip reduces the possibility of operator's hands slipping onto working end of tool
- Tempered stainless steel wedge with counter-angled friction ridges for stability and slippage prevention
- Wedge: 2” x 4”
- Length: 32.5”
- Weight: 7.5 lbs.
- **SPECIAL NOTE: This Blackhawk product is restricted to Emergency Response Personnel, Military, Law Enforcement and Security Personnel ONLY**



Part Number	Description	Color	NSN#
DE-UKHT	U.K. Hallagan Tool	Black	4210-01-517-7056

DYNAMIC ENTRY® NON-SPARKING, ELECTRICALLY NONCONDUCTIVE HALLAGAN TOOL SERIES



- Ergonomic handle reinforces proper hand placement
- Fork and horn end for prying and breaching
- Use with Dynamic Entry® ThunderSledge™ tools to effectively breach padlocks
- Length: 24” (Special Operations), 29.5” (Standard), 40” (Gorilla Bar)
- Weight: 7.5 lbs. (Special Operations), 8 lbs. (Standard), 17.5 lbs. (Gorilla Bar)
- **SPECIAL NOTE: This Blackhawk product is restricted to Emergency Response Personnel, Military, Law Enforcement and Security Personnel ONLY**
- **NOTE: The non-sparking alloy used in these tools is not intended for use on steel doors and frames. If breaching steel doors Dynamic Entry® recommends using one of our stainless steel tools, such as the Stainless HallaganTool™.**



Part Number	Description	Color	NSN#
DE-SOHT	Special Operations Hallagan Tool	Black	5120-01-507-1498
DE-HT	Hallagan Tool	Black	5120-01-579-9042
DE-GB	Gorilla Bar	Black	5120-01-604-1153

DYNAMIC ENTRY® STAINLESS HALLAGAN TOOL SERIES



- Safety-guard handgrip reduces the possibility of operator's hands slipping onto working end of tool
- Tempered stainless steel wedge with counter-angled friction ridges for stability and slippage prevention
- Length: 24” (Special Operations), 31” (Stainless Hallagan)
- Weight: 8 lbs. (Special Operations), 8 lbs. (Stainless Hallagan)
- **SPECIAL NOTE: This Blackhawk product is restricted to Emergency Response Personnel, Military, Law Enforcement and Security Personnel ONLY**



Part Number	Description	Color	NSN#
DE-SOSHT	Special Operations Stainless Hallagan Tool	Black	
DE-SHTB	Stainless Hallagan Tool	Black	5120-01-554-3768

DYNAMIC ENTRY® CLASSIC HALLAGAN TOOL



- One-piece, drop-forged alloy steel made to exacting standards in the USA
- Forged-in sling attachments
- Includes sling
- Horn: 4.25"
- Length: 30"
- Weight: 10 lbs.
- **SPECIAL NOTE: This Blackhawk product is restricted to Emergency Response Personnel, Military, Law Enforcement and Security Personnel ONLY**



Part Number	Description	Color
DE-CHT30	Classic Hallagan Tool	Black

DYNAMIC ENTRY® SPECIAL OPERATIONS ENTRY RAM



- Ergonomic control-flex handle system reduces impact stress
- Ambidextrous handle orientation for one- or two-person operation
- Forward-weighted design is a close-quarter alternative to the MonoShock Ram™
- Length: 25"
- Weight: 30 lbs.
- **SPECIAL NOTE: This Blackhawk product is restricted to Emergency Response Personnel, Military, Law Enforcement and Security Personnel ONLY**



Part Number	Description	Color
DE-SOER	Special Operations Entry Ram	Black

DYNAMIC ENTRY® MONOSHOCK™ RAM



- Ergonomic control-flex handle system reduces impact stress
- Includes padded quick-release sling
- Length: 31.5"
- Weight: 32 lbs.
- **SPECIAL NOTE: This Blackhawk product is restricted to Emergency Response Personnel, Military, Law Enforcement and Security Personnel ONLY**



Part Number	Description	Color	NSN#
DE-MS	MonoShock Ram	Black	4210-01-517-7055

DYNAMIC ENTRY® CQB™ RAM



- Oversized control-flex handle system keeps breachers outside the "fatal funnel" even in cramped areas
- Length: 20"
- Weight: 23 lbs.
- **SPECIAL NOTE: This Blackhawk product is restricted to Emergency Response Personnel, Military, Law Enforcement and Security Personnel ONLY**



Part Number	Description	Color	NSN#
DE-CQB	CQB Ram	Black	4210-01-522-1018

Blackhawk.com

DYNAMIC ENTRY® TWIN TURBO™



- Designed for one- or two-person operation
- Ergonomic control-flex handle system reduces impact stress
- Includes padded quick-release sling
- Length: 40"
- Weight: 41.5 lbs.
- **SPECIAL NOTE: This Blackhawk product is restricted to Emergency Response Personnel, Military, Law Enforcement and Security Personnel ONLY**



Part Number	Description	Color	NSN#
DE-TT	Twin Turbo	Black	4210-01-517-7054

DYNAMIC ENTRY® THOR'S HAMMER



- Sure-grip handle system reduces slippage during operations
- Operator-friendly design allows it to be swung outside the "fatal funnel"
- Length: 24"
- Weight: 15.4 lbs.
- **SPECIAL NOTE: This Blackhawk product is restricted to Emergency Response Personnel, Military, Law Enforcement and Security Personnel ONLY**



Part Number	Description	Color	NSN#
DE-TH	Thor's Hammer	Black	4210-01-598-8932

DYNAMIC ENTRY® BOLTMASTER™ SERIES



- Heat-treated cutting edges
- Lightweight and durable, each head features a tension adjustment
- Safety-guard handgrip reduces the possibility of operator's hands slipping onto working end of tool
- For use on security chains, chain link fences and non-case-hardened locks
- Jaw opening: 3/8" (Mini), 3/8" (BoltMaster), 7/16" (Super)
- Length: 18" (Mini), 24" (BoltMaster), 30" (Super)
- Weight: 5.15 lbs. (Mini), 5.75 lbs. (BoltMaster), 8 lbs. (Super)
- **SPECIAL NOTE: This Blackhawk product is restricted to Emergency Response Personnel, Military, Law Enforcement and Security Personnel ONLY**



Part Number	Description	Color	NSN#
DE-MBM	Mini BoltMaster	Black	
DE-BM	BoltMaster	Black	5110-00-224-7056
DE-SBM	Super BoltMaster	Black	5110-01-532-4999

DYNAMIC ENTRY® BOLTMASTER™ SLING



- Designed to carry the BoltMaster™ hands-free and at the ready
- Constructed of heavy duty nylon with hook & loop attachment points and a padded shoulder strap

Part Number	Description	Color
DE-BMSL	BoltMaster Sling	Black



DYNAMIC ENTRY® PADLOCK BUSTER



- Designed for situations where the BoltMaster™ is not recommended
- Classic duckbill design for use on various padlock sizes
- Constructed of military-grade AR400 steel
- Length: 24.25"
- Weight: 6.3 lbs.
- **SPECIAL NOTE: This Blackhawk product is restricted to Emergency Response Personnel, Military, Law Enforcement and Security Personnel ONLY**

Part Number	Description	Color
DE-PB	Padlock Buster	Black



DYNAMIC ENTRY® TACTICAL FENCE CLIMBERS



- Provide a scaling rung on both sides of the fence for easy and rapid egress
- Lightweight construction
- Folds up for easy storage
- Set of four weighs 5.2 lbs.
- **SPECIAL NOTE: This Blackhawk product is restricted to Emergency Response Personnel, Military, Law Enforcement and Security Personnel ONLY**

Part Number	Description	Color
DE-TFC	Tactical Fence Climbers	Black



DYNAMIC ENTRY® MANUAL ENTRY TOOL PACK (PACK ONLY)



- Constructed of durable 1000 denier nylon and heavily padded with closed-cell foam
- Retention straps hold tools securely in individual pouches
- Fully adjustable chest and waist straps
- Carries BoltMaster; Special Operations Hallagan Tool or Special Operations Breacher; and ThunderMaul™ or Mini ThunderSledge™

Part Number	Description	Color
60ME00BK	Manual Entry Tool Pack	Black



DYNAMIC ENTRY® TACTICAL BACKPACK KIT



- Includes Dynamic Entry® BoltMaster™ (DE-BM)
- Includes Dynamic Entry® ThunderMaul™ (DE-TM)
- Includes Dynamic Entry® Special Operations Hallagan Tool (DE-SOHT)
- Includes Dynamic Entry® Manual Entry Tool Pack (60ME00BK)
- **SPECIAL NOTE: This Blackhawk product is restricted to Emergency Response Personnel, Military, Law Enforcement and Security Personnel ONLY**

Part Number	Description	Color
DE-TBK	Tactical Backpack Kit	Black



DYNAMIC ENTRY® TACTICAL BACKPACK KIT-B



- Includes Dynamic Entry® BoltMaster™ (DE-BM)
- Includes Dynamic Entry® ThunderMaul™ (DE-TM)
- Includes Dynamic Entry® Special Operations Breacher (DE-SOB)
- Includes Dynamic Entry® Manual Entry Tool Pack (60ME00BK)
- **SPECIAL NOTE: This Blackhawk product is restricted to Emergency Response Personnel, Military, Law Enforcement and Security Personnel ONLY**

Part Number	Description	Color
DE-TBK-B	Tactical Backpack Kit B	Black



DYNAMIC ENTRY® TACTICAL BACKPACK KIT-C



- Includes Dynamic Entry® BoltMaster™ (DE-BM)
- Includes Dynamic Entry® ThunderMaul™ (DE-TM)
- Includes Dynamic Entry® Active Shooter Hallagan Tool (DE-ASHT)
- Includes Dynamic Entry® Manual Entry Tool Pack (60ME00BK)
- **SPECIAL NOTE: This Blackhawk product is restricted to Emergency Response Personnel, Military, Law Enforcement and Security Personnel ONLY**

Part Number	Description	Color
DE-TBK-C	Tactical Backpack Kit C	Black



DYNAMIC ENTRY® U.K. M.O.E.® TOOL PACK (PACK ONLY)

- Fully adjustable shoulder, waist and under-the-leg straps keep pack anchored to operator's body
- Two large retention flaps
- **SPECIAL NOTE: This Blackhawk product is restricted to Emergency Response Personnel, Military, Law Enforcement and Security Personnel ONLY**

Part Number	Description	Color
990662BK	U.K. M.O.E. Tool Pack	Black



DYNAMIC ENTRY® U.K. M.O.E.® BACKPACK KIT



- Designed for Special Forces units worldwide
- Includes Dynamic Entry® Super BoltMaster™ (DE-SBM)
- Includes Dynamic Entry® CQB Ram™ (DE-CQB)
- Includes Dynamic Entry® U.K. Hallagan Tool (DE-UKHT)
- Includes Dynamic Entry® U.K. M.O.E.™ Tool Pack (990662BK)
- **SPECIAL NOTE: This Blackhawk product is restricted to Emergency Response Personnel, Military, Law Enforcement and Security Personnel ONLY**

Part Number	Description	Color	NSN#
DE- UKMOEK	U.K. M.O.E. Backpack Kit	Black	4210-01-572-5019



DYNAMIC ENTRY® MODULAR BACKPACK

- Integrates S.T.R.I.K.E.® webbing, Speed Clip™ devices and Dynamic Entry Modular Attachment System
- Constructed of durable 1000 denier nylon
- Lumbar padding and wide shoulder straps for maximum comfort
- Large tear-resistant, kydex-lined tool pouch with reinforced drain holes
- Modular retention straps for quick and secure mission specific tool configurations
- Includes assortment of various sized modular retention straps
- **SPECIAL NOTE: This Blackhawk product is restricted to Emergency Response Personnel, Military, Law Enforcement and Security Personnel ONLY**

Part Number	Description	Color
DE- MBP	Modular Backpack	Black



/ HOLSTERS / DUTY + PROTECTIVE / APPAREL / BAGS + PACKS / ACCESSORIES /

DYNAMIC ENTRY® MINI DEPLOYMENT BAG

- Carries Mini BoltMaster™, Mini Breacher and Mini ThunderSledge™
- Heavy-duty drag handle
- Shoulder strap with quick-release buckles for ambidextrous carry
- Thigh straps for added stability during extreme body movements
- Internal compartments keep tools secure and reduce noise signature
- Two multipurpose side pockets

Part Number	Description	Color
60ME03BK	Mini Deployment Bag	Black



DYNAMIC ENTRY® MINI DEPLOYMENT KIT



- Includes Dynamic Entry® Mini Breacher (DE-MB)
- Includes Dynamic Entry® Micro ThunderSledge™ (DE-MCR)
- Includes Dynamic Entry® Mini BoltMaster™ (DE-MBM)
- Includes Dynamic Entry® Mini Deployment Bag (60ME03BK)
- **SPECIAL NOTE: This Blackhawk product is restricted to Emergency Response Personnel, Military, Law Enforcement and Security Personnel ONLY**

Part Number	Description	Color
DE- MDK	Mini Deployment Kit	Black



DYNAMIC ENTRY® MINI TOOL KIT / MTK



- Includes Speed Clips™
- Includes Dynamic Entry® Mini Breacher (DE-MB)
- Includes Dynamic Entry® Micro ThunderSledge™ (DE-MCR)
- Includes Dynamic Entry® Mini BoltMaster™ (DE-MBM)
- Includes two Dynamic Entry® Single Tool Carriers (5100856BK)
- Includes Dynamic Entry® Mini BoltMaster™ Pouch (5100880BK)
- **SPECIAL NOTE: This Blackhawk product is restricted to Emergency Response Personnel, Military, Law Enforcement and Security Personnel ONLY**

Part Number	Description	Color
DE- MTK	Mini Tool Kit	Black



DYNAMIC ENTRY® ENTRY KIT #1 / MTO



- Save 10 percent on MonoShock Ram™ and Dynamic Duo together
- Includes Dynamic Entry® MonoShock Ram™ (DE-MS)
- Includes Dynamic Entry® Dynamic Duo™ (DE-DD)
- **SPECIAL NOTE: This Blackhawk product is restricted to Emergency Response Personnel, Military, Law Enforcement and Security Personnel ONLY**

Part Number	Description	Color
DE-EK1	Entry Kit #1	Black



DYNAMIC ENTRY® ENTRY KIT #2 / MTO



- Combines the MonoShock Ram™ and Break-N-Rake™ with the Tactical Backpack Kit
- Includes Dynamic Entry® MonoShock Ram™ (DE-MS)
- Includes Dynamic Entry® Break-N-Rake™ (DE-BR)
- Includes Dynamic Entry® Tactical Backpack Kit-B (DE-TBK-B)
- **SPECIAL NOTE: This Blackhawk product is restricted to Emergency Response Personnel, Military, Law Enforcement and Security Personnel ONLY**

Part Number	Description	Color
DE-EK2	Entry Kit #2	Black



DYNAMIC ENTRY® ENTRY KIT #3 / MTO



- Includes Dynamic Entry® MonoShock Ram™ (DE-MS)
- Includes Dynamic Entry® Dynamic Duo™ (DE-DD)
- Includes Dynamic Entry® Break-N-Rake™ (DE-BR)
- Includes Dynamic Entry® Mobile Home Door Breacher (DE-MHB)
- Includes Dynamic Entry® Tactical Backpack Kit-B (DE-TBK-B)
- **SPECIAL NOTE: This Blackhawk product is restricted to Emergency Response Personnel, Military, Law Enforcement and Security Personnel ONLY**

Part Number	Description	Color
DE-EK3	Entry Kit #3	Black



/ HOLSTERS / DUTY + PROTECTIVE / APPAREL / BAGS + PACKS / ACCESSORIES /

PLATE CARRIERS

S.T.R.I.K.E.® CUTAWAY PLATE CARRIER

- Simple construction for quick attachment and detachment (cutaway can be easily disabled)
- Constructed of 500 denier CORDURA® nylon (MultiCam®) or 500 denier ripstop nylon (solid colors)
- Front shoulder panel quick-release strap with rounded handle under protective nylon band
- Heavy-duty drag handle
- Adjustable waist and shoulder system for tailored girth and torso fit
- Multiple rows of S.T.R.I.K.E.® webbing for attaching pouches, holsters or accessories
- Front plate pocket with inverted “T” elastic keeper accommodates bib when plates are not in use
- Ambidextrous design
- Accommodates Blackhawk Ballistic Ceramic in fully adjustable front/rear pockets and removable side plate pouches



Part Number	Description	Color
32V701CT	S.T.R.I.K.E. Cutaway Plate Carrier	Coyote Tan
32V701OD	S.T.R.I.K.E. Cutaway Plate Carrier	Olive

LOW VIS PLATE CARRIER

- Lightweight, close-fitting design
- Constructed of 500 denier CORDURA® nylon (MultiCam®) or 500 denier ripstop nylon (solid colors)
- Slim enough to be worn under clothes for low visibility
- Adjustable shoulder and side straps (one size fits all)
- Side-release buckles for quick donning and doffing
- Front hook & loop panel for ID patch
- SM/MD version accommodates Blackhawk Ballistic Ceramic Plates up to 9.5” x 12.5”
- LG/XL version accommodates Blackhawk Ballistic Ceramic Plates up to 10.5” x 13.25”



Part Number	Description	Size	Color
32PC08BK	Low Vis Plate Carrier	SM/MD	Black
32PC08CT	Low Vis Plate Carrier	SM/MD	Coyote Tan
32PC12BK	Low Vis Plate Carrier	LG/XL	Black
32PC12CT	Low Vis Plate Carrier	LG/XL	Coyote Tan

S.T.R.I.K.E.® LIGHTWEIGHT PLATE CARRIER HARNESS

- Constructed of 500 denier
- Multiple rows of S.T.R.I.K.E.® webbing for attaching pouches, holsters or accessories
- Heavy-duty drag handle
- Dual-adjust side-release buckles for fit adjustment
- SM/MD version accommodates Blackhawk Ballistic Ceramic Plates up to 9.5" x 12.5
- LG/XL version accommodates Blackhawk Ballistic Ceramic Plates up to 10.5" x 13.25"
- Weight (SM/MD): 1.3 lbs.
- Weight (LG/XL): 1.5 lbs.

Part Number	Description	Color	Size
37CL83BK	S.T.R.I.K.E.® Lightweight Plate Carrier Harness	Black	SM/MD
37CL83CT	S.T.R.I.K.E.® Lightweight Plate Carrier Harness	Coyote Tan	SM/MD
37CL84BK	S.T.R.I.K.E.® Lightweight Plate Carrier Harness	Black	LG/XL



Front



Back

MODULAR DROP LEG PLATFORM



- Constructed of high-density polymer for comfort and flexibility
- Y-harness configuration with heavy-duty hanger straps and quick-release buckles
- Dual non-slip BTS™ belt loops
- Removable 1.5" non-slip upper leg strap and 2" non-slip lower leg strap for maximum stability
- Ventilated for increased airflow
- Four adjustable accessory rails hold four pouches, mag/light carriers or duty gear accessories

Part Number	Description	Color
432300PBK	Modular Drop-Leg Platform	Black



DUTY ACCESSORY MOUNTING SCREW KIT



- Required for mounting Blackhawk duty gear accessories onto Modular Drop Leg or SERPA® Tactical Holster Platform

Part Number	Description
44AK0001	Duty Accessory Mounting Screw Kit



S.T.R.I.K.E.® COMPACT DROP-LEG PLATFORM

- Constructed of 500 denier nylon
- Modular drop leg platform with reduced footprint
- 1.5" wide elastic rubberized leg strap for stability and comfort
- Y-harness configuration and heavy-duty hanger straps with quick-detach swivel buckles
- Tapered, foam-padded platform
- Three rows of S.T.R.I.K.E.® webbing for attaching pouches or accessories
- Dimensions: 5.5"H x 9"W



Part Number	Description	Color
37CL125BK	S.T.R.I.K.E. Compact Drop-Leg Platform	Black

S.T.R.I.K.E.® DROP LEG PLATFORM

- Constructed of 1000 denier nylon
- Five rows of S.T.R.I.K.E.® webbing for attaching pouches or accessories
- Elastic rubberized leg straps for stability and comfort
- Dimensions: 10"H x 9"W



Part Number	Description	Color	NSN#
37CL39BK	S.T.R.I.K.E. Drop Leg Platform	Black	
37CL39CT	S.T.R.I.K.E. Drop Leg Platform	Coyote Tan	8465-01-559-0654

ΩMEGA ELITE® DROP LEG EXTENDER

- Extends gear below belt by five inches
- Attaches to drop leg holsters, pouches and rigs



Part Number	Description	Color	NSN#
56DLE2BK	Omega Elite Drop-Leg Extender	Black	8465-01-564-6256

ΩMEGA ELITE® MODULAR DROP LEG MEDICAL POUCH

- Constructed of 1000 denier nylon
- IVS™ (Intercooler Venting System) back panel for ventilation
- Drainage grommets in bottom of pouches
- Securely mounts to thigh, belt or vest
- Dimensions: 7.75"H x 6.75"W x 2"D



Part Number	Description	Color	NSN#
56MP00BK	Omega Elite Modular Drop Leg Medical Pouch	Black	6545-01-504-3085

M16 "Y" THIGH RIG

- Drop leg configuration holds four M16 magazines
- Constructed of lightweight yet durable 500 denier ripstop
- Two mag pouches on front hold two M16 magazines each
- Y-configuration with heavy-duty hanger straps and quick detach swivel buckles
- Elastic rubberized leg straps for stability and comfort
- Fully adjustable lid height

Part Number	Description	Color
561604BK	M16 "Y" Thigh Rig	Black



ΩMEGA ELITE® M16 MAG POUCH

- Constructed of 1000 denier nylon
- IVS™ (Intercooler Venting System) back panel for ventilation
- Drainage grommets in bottom of pouches
- Carries two M16/M4 30-round magazines

Part Number	Description	Color
561601BK	Omega Elite M16 Mag Pouch	Black



ΩMEGA ELITE® ENHANCED M16 DROP LEG MAG POUCH

- Constructed of 1000 denier nylon
- IVS™ (Intercooler Venting System) back panel for ventilation
- Drainage grommets in bottom of pouches
- Pouch dividers prevent mag clatter and enhance noise discipline
- Carries four M16/M4 30-round mags

Part Number	Description	Color
561602BK	Omega Elite Enhanced M16 Drop Leg Mag Pouch	Black



ΩMEGA ELITE® GAS MASK POUCH

- Constructed of 1000 denier nylon
- IVS™ (Intercooler Venting System) back panel for ventilation
- Drainage grommets in bottom of pouches
- Adjustable, removable shoulder strap
- Heavy-duty drop leg hanger with BTS™ belt loops
- Side-release buckles and hook & loop closure
- Dimensions: 9.75"H x 6.25"W x 5"D

Part Number	Description	Color	NSN#
56GM00BK	Omega Elite Gas Mask Pouch	Black	4210-01-504-3082



ULTRALIGHT ΩMEGA ELITE® GAS MASK POUCH

- Constructed of lightweight 500 denier ripstop nylon
- Adjustable, removable shoulder strap and non-slip leg straps
- Y-harness configuration with heavy-duty hanger straps and quick-release swivel buckles
- Side-release buckles and hook & loop closure
- Dual non-slip BTS™ belt loops
- 1/8" padded back
- Dimensions: 11"H x 5" – 7.25"W x 4"D
- Cuff pouch: 4"H x 2.25" – 4.5"W

Part Number	Description	Color
56GM03BK	Ultralight Omega Elite Gas Mask Pouch	Black



LRAK M240/SAW GUNNER KIT

- Two 100-round 240 pouches (also fits 200-round SAW box)
- Two 200-round 7.62 pouches (also fits 200-round SAW box)
- Two 1-qt. canteen pouches and two pop flare pouches
- One gunner tool pouch, one strobe/compass pouch, one enhanced butt pack and one flashlight pouch
- S.T.R.I.K.E.® webbing on shoulders for attaching pouches or accessories
- Elastic retention strap for fins or slung rifle

Part Number	Description	Color	NSN#
30HH03MC	LRAK M240/SAW Gunner Kit	Multicam	8415-01-563-3973



COMMANDO CHEST HARNESS

- Durable 1000 denier nylon with adjustable, padded cross straps with .25" closed-cell foam
- Adjustable quick-release waist strap
- Four ammo pouches hold two AK-47, three M16 or two M14 magazines each
- Pouch dividers prevent magazine clatter and enhance noise discipline
- Two end utility pouches hold radios, rations, compasses, etc.
- Large internal utility/map pouch with securing flap
- Belt loops secure vest to any web belt

Part Number	Description	Color
55C000BK	Commando Chest Harness	Black
55C000DE	Commando Chest Harness	Desert Tan



CHEST MAGAZINE POUCH

- Constructed of durable, lightweight 500 denier ripstop and type 4 nylon webbing
- One size fits all with adjustable shoulder and waist straps
- Holds eight 30-round rifle magazines and two pistol magazines
- Pouches include grommets for drainage and hook & loop lid closures
- Available for M16/M4 (Black) and AK-47 (Coyote Tan)



Part Number	Description	Color
55CP01BK	M16/M4 Chest Magazine Pouch	Black
55CP04CT	AK-47 Chest Pouch	Coyote Tan

RIFLE/PISTOL BANDOLEER

- Holds four rifle magazines and two pistol magazines
- Cross-torso/shoulder-carried bandoleer with quick-release buckle for fast removal
- Padded back panel and two belt keepers on back panel secure around belt by snap fasteners
- Two M16/M4 adjustable flap mag pouches with silencing dividers in center
- Pistol mag pouches with adjustable flaps
- D-rings at bottom corners for securing to waist belt
- Dimensions: 6.5"H x 11.5"W



Part Number	Description	Color
55RB01BK	Rifle/Pistol Bandoleer	Black

RIFLE BANDOLEER

- Holds six M16/M4 magazines
- Perfect for active shooter response
- Ambidextrous shoulder rig with non-slip pad
- Stabilizing quick-release waist strap



Part Number	Description	Color
55S0S1BK	Rifle Bandoleer	Black

PATROL RADIO HARNESS

- Holds radios and other small hardware
- Internal pouch for maps and documents
- Adjustable for all portable radio sizes
- Quick-release buckles and elastic antenna support



Part Number	Description	Color	NSN#
37PRH1BK	Patrol Radio Harness	Black	8465-01-598-9133

LOAD BEARING SUSPENDERS

- Wraparound belt loop system
- Heavy-duty drag handles and sternum strap
- No metal attachment clips
- Belt not included

Part Number	Description	Color
35LBS1BK	Load Bearing Suspenders	Black
35LBS10D	Load Bearing Suspenders	Olive Drab



VESTS

S.T.R.I.K.E.[®] OMEGA™ VEST

- Adjustable for length and girth (up to 6" length and 32" girth)
- Heavy-duty YKK[®] zipper and side-release buckles for rapid donning and doffing
- Belt loops secure vest to web belt
- Reinforced drag handle for operator evacuation if injured
- S.T.R.I.K.E.[®] webbing for attaching pouches or accessories
- Constructed of durable nylon mesh for maximum breathability
- Padded non-slip shoulders for fully ambidextrous vest
- Lace-style girth adjustment
- Two Large internal zippered accessory pockets on both front panels (8.5"H x 10"W)
- Shoulder D-rings for accessory attachment



Part Number	Description	Color	NSN#
37CL36BK	S.T.R.I.K.E. Omega Vest	Black	8470-01-517-6331

S.T.R.I.K.E.[®] ELITE VEST

- Adjustable for length and girth (up to 6" length and 32" girth)
- Heavy-duty YKK[®] zipper and side-release buckles for rapid donning and doffing
- Belt loops secure vest to web belt
- Reinforced drag handle for operator evacuation if injured
- S.T.R.I.K.E.[®] webbing for attaching pouches or accessories
- Constructed of durable nylon mesh for maximum breathability
- Padded non-slip shoulders for fully ambidextrous vest
- Side-release buckle and web-style girth adjustment
- Shoulder D-rings for accessory attachment
- Two large internal zippered accessory pockets on both front panels (8.5"H x 10"W)



Part Number	Description	Color
37CL66BK	S.T.R.I.K.E. Elite Vest	Black

OMEGA ELITE™ TACTICAL VEST #1

- Adjustable for length and girth (up to 6" length and 32" girth)
- Heavy-duty YKK® zipper and side-release buckles for rapid donning and doffing
- Belt loops secure vest to web belt
- Reinforced drag handle for operator evacuation if injured
- S.T.R.I.K.E.® webbing for attaching pouches or accessories
- Constructed of durable nylon mesh for maximum breathability
- Padded non-slip shoulders for fully ambidextrous vest
- Two Large internal zippered accessory pockets on both front panels (8.5"H x 10"W)
- Mag pouches with adjustable flaps for tall or short magazines
- Two horizontal accessory pouches
- Six M16/M4 mag pouches hold 12 magazines total
- Includes removable shotshell strip
- Hook & loop strip for I.D. Patch



Part Number	Description	Color
30EV03BK	Omega Elite Tactical Vest 1	Black

OMEGA® PHALANX HOMELAND SECURITY VEST

- Adjustable for length and girth (up to 6" length and 32" girth)
- Heavy-duty YKK® zipper and side-release buckles for rapid donning and doffing
- Belt loops secure vest to web belt
- Reinforced drag handle for operator evacuation if injured
- S.T.R.I.K.E.® webbing for attaching pouches or accessories
- Constructed of durable nylon mesh for maximum breathability
- Padded non-slip shoulders for fully ambidextrous vest
- Two large internal zippered accessory pockets on both front panels (8.5"H x 10"W)
- Two M16/M4 pouches hold four magazines total (one has a Securing cord for radio)
- Mag pouches with adjustable flaps for tall or short magazines
- Pouches for flashbangs, handcuffs, O.C. spray and tactical light
- 14-round shotshell pouch
- Includes removable shotshell strip



Part Number	Description	Color
30EV35BK	Omega Phalanx Homeland Security Vest	Black
30EV35CT	Omega Phalanx Homeland Security Vest	Coyote Tan

MTO

OMEGA® TACTICAL VEST MEDIC/UTILITY

- Adjustable for length and girth (up to 6" length and 32" girth)
- Heavy-duty YKK® zipper and side-release buckles for rapid donning and doffing
- Belt loops secure vest to web belt
- Reinforced drag handle for operator evacuation if injured
- S.T.R.I.K.E.® webbing for attaching pouches or accessories
- Constructed of durable nylon mesh for maximum breathability
- Padded non-slip shoulders for fully ambidextrous vest
- Two large internal zippered accessory pockets on both front panels (8.5"H x 10"W)
- Hook & loop strip for ID patch
- Eight utility pouches for medical supplies and gear



Part Number	Description	Color
30EV08BK	Omega Tactical Vest Medic/Utility	Black

OMEGA ELITE™ CROSS DRAW/PISTOL MAG VEST

- Adjustable for length and girth (up to 6" length and 32" girth)
- Heavy-duty YKK® zipper and side-release buckles for rapid donning and doffing
- Belt loops secure vest to web belt
- Reinforced drag handle for operator evacuation if injured
- S.T.R.I.K.E.® webbing for attaching pouches or accessories
- Constructed of durable nylon mesh for maximum breathability
- Padded non-slip shoulders for fully ambidextrous vest
- Two large internal zippered accessory pockets on both front panels (8.5"H x 10"W)
- Hook and loop strip for I.D. under
- Cross-draw holster secured by adjustable side-release buckle
- Mag pouches with adjustable flaps for tall or short magazines
- Three M16/M4 pouches hold six magazines total
- Four pistol magazine pouches and one horizontal accessory pouch



Part Number	Description	Color
30EV26BK	Omega Elite Cross Draw/Pistol Mag Vest	Black

D.O.A.V. ASSAULT VEST SYSTEM

- Adjustable for length and girth (up to 6" length and 32" girth)
- Heavy-duty YKK® zipper and side-release buckles for rapid donning and doffing
- Belt loops secure vest to web belt
- Reinforced drag handle for operator evacuation if injured
- S.T.R.I.K.E.® webbing for attaching pouches or accessories
- Constructed of durable nylon mesh for maximum breathability
- Padded non-slip shoulders for fully ambidextrous vest
- Shoulder D-rings for accessory attachment
- Two large internal zippered accessory pockets on both front panels (8.5"H x 10"W)
- Four M16/M4 pouches with internal securing straps and dividers hold three magazines each
- Three utility/flashbang pouches and five internal elastic keepers for pens, chem-lights, etc.
- Side light/utility/flashbang pouch and two large daypacks on back for gear, helmets, radio, etc.



Part Number	Description	Color
30DV00BK	D.O.A.V. Assault Vest System	Black

TACTICAL FLOAT VEST II

- Adjustable for length and girth (up to 6" length and 32" girth)
- Heavy-duty YKK® zipper and side-release buckles for rapid donning and doffing
- Belt loops secure vest to web belt
- Reinforced drag handle for operator evacuation if injured
- S.T.R.I.K.E.® webbing for attaching pouches or accessories
- Constructed of heavy duty 1000 denier nylon for maximum strength and durability
- U.S. Coast Guard-approved foam
- Non-slip right shoulder for proper stock-weld
- Shoulder D-rings for accessory attachment
- Mag pouches with adjustable flaps for tall or short magazines
- Two Large internal zippered accessory pockets on both front panels (8.5"H x 10"W)
- Two M16/M4 ammo pouches on front hold six magazines total
- Pouches secured with side-release buckles and hook & loop
- Cargo pocket with elastic weave for small items
- Strobe/compass pouch secured by hook & loop flap
- Cargo pocket for medical kit (not included) on right-front panel
- Pouch for Mark 13 day/night flare
- Pocket for several pencil flares and chem-lights
- Small pocket for crotch straps on back secure to front of vest



Part Number	Description	Color
30TFV2BK	Tactical Float Vest II	Black

Sizing:	
XS	22"-24"
SM	26"-30"
MD	32"-36"
LG	38"-42"
XL	44"-48"
2XL	50-54"

When ordering, please identify the size BEFORE the color. For example 44B6SMBK

CQB/RIGGER'S BELT



- Parachute-grade buckles and adapters meet PIA-H-7195 standards
- 1.75" webbing with 7,000-lb. tensile strength (solid colors) or 5,000-lb. tensile strength (MultiCam®)
- Hook & loop secures running end

Part Number	Description	Color	Size	NSN#
41CQ00BK	CQB/Rigger's Belt	Black	to 34"	4240-01-519-2622
41CQ00OD	CQB/Rigger's Belt	Olive	to 34"	4240-01-596-2112
41CQ00DE	CQB/Rigger's Belt	Desert Tan	to 34"	4240-01-586-2392
41CQ00DB	CQB/Rigger's Belt	Brown	to 34"	
41CQ00MC	CQB/Rigger's Belt	MultiCam®	to 34"	
41CQ01BK	CQB/Rigger's Belt	Black	to 41"	4240-01-509-6087
41CQ01OD	CQB/Rigger's Belt	Olive	to 41"	4240-01-596-2113
41CQ01DE	CQB/Rigger's Belt	Desert Tan	to 41"	4240-01-529-7437
41CQ01DB	CQB/Rigger's Belt	Brown	to 41"	
41CQ01MC	CQB/Rigger's Belt	MultiCam®	to 41"	
41CQ02BK	CQB/Rigger's Belt	Black	41"-51"	4240-01-509-6086
41CQ02OD	CQB/Rigger's Belt	Olive	41"-51"	4240-01-519-2779
41CQ02DE	CQB/Rigger's Belt	Desert Tan	41"-51"	4240-01-560-6022
41CQ02DB	CQB/Rigger's Belt	Brown	41"-51"	
41CQ02MC	CQB/Rigger's Belt	MultiCam®	41"-51"	



CQB/RIGGER'S BELT WITH COBRA BUCKLE



Part Number	Description	Color	Size
41CQ11BK	Rigger's Belt w/ Cobra Buckle	Black	to 34"
41CQ12BK	Rigger's Belt w/ Cobra Buckle	Black	to 41"
41CQ13BK	Rigger's Belt w/ Cobra Buckle	Black	41"-51"
41CQ11DB	Rigger's Belt w/ Cobra Buckle	Brown	to 34"
41CQ12DB	Rigger's Belt w/ Cobra Buckle	Brown	to 41"
41CQ13DB	Rigger's Belt w/ Cobra Buckle	Brown	41"-51"
41CQ11DE	Rigger's Belt w/ Cobra Buckle	Desert Sand	to 34"
41CQ12DE	Rigger's Belt w/ Cobra Buckle	Desert Sand	to 41"
41CQ13DE	Rigger's Belt w/ Cobra Buckle	Desert Sand	41"-51"
41CQ11OD	Rigger's Belt w/ Cobra Buckle	Olive Drab	to 34"
41CQ12OD	Rigger's Belt w/ Cobra Buckle	Olive Drab	to 41"
41CQ13OD	Rigger's Belt w/ Cobra Buckle	Olive Drab	41"-51"
41CQ11MC	Rigger's Belt w/ Cobra Buckle	MultiCam®	to 34"
41CQ12MC	Rigger's Belt w/ Cobra Buckle	MultiCam®	to 41"
41CQ13MC	Rigger's Belt w/ Cobra Buckle	MultiCam®	41"-51"



INSTRUCTOR'S GUN BELT - 1.5"



- Polyethylene spine to help bear the weight of belt-mounted holsters and equipment
- Parachute-grade buckles and adapters meet PIA-H-7195 standards
- 1.5" webbing with 7,000-lb. tensile strength (solid colors) or 4,000-lb. tensile strength (MultiCam®)
- Hook & loop secures running end

Part Number	Description	Color	Size
41VT10BK	Instructor's Gun Belt - 1.5"	Black	to 34"
41VT10MC	Instructor's Gun Belt - 1.5"	MultiCam®	to 34"
41VT11BK	Instructor's Gun Belt - 1.5"	Black	to 41"
41VT11MC	Instructor's Gun Belt - 1.5"	MultiCam®	to 41"
41VT12BK	Instructor's Gun Belt - 1.5"	Black	41"-51"
41VT12MC	Instructor's Gun Belt - 1.5"	MultiCam®	41"-51"



/ HOLSTERS / DUTY + PROTECTIVE / APPAREL / BAGS + PACKS / ACCESSORIES /

INSTRUCTOR'S GUN BELT - 1.75"



- Polyethylene spine to help bear the weight of belt-mounted holsters and equipment
- Parachute-grade buckles and adapters meet PIA-H-7195 Standards
- 1.75" webbing with 7,000-lb. tensile strength
- Hook & loop secures running end

Part Number	Description	Color	Size
41VT01BK	Instructor's Gun Belt – 1.75"	Black	34"-41"
41VT02BK	Instructor's Gun Belt – 1.75"	Black	42"-52"



2" WEB DUTY BELT



- Double-layer nylon web design
- Triple-retention buckle and molded keepers for tough use

Part Number	Description	Color	Size
44B6_BK	2" Web Duty Belt	Black	SM-XL



REINFORCED 2" WEB DUTY BELT



- Double-layer nylon web design with polymer spine reinforcement
- Nylon binding for smooth edge, comfort and professional appearance
- Triple-retention buckle and molded keepers for tough use



Part Number	Description	Color	Size
44B3_BK	Reinforced 2" Web Duty Belt	Black	SM-XL

ERGONOMIC DUTY BELT HARNESS



- Broad fit range and no moving parts to fail
- NIJ selected and funded to address back and hip pain
- Helps alleviate discomfort caused by heavy-duty belts
- Eliminates issues associated with external suspender systems
- Can be worn under duty shirt with slight modifications
- Compatible with most concealment armor packages
- Accommodates duty belts up to 2.25" wide



Part Number	Description	Color	Size
44H001_BK	Ergonomic Duty Belt Harness	Black	SM/MD
44H002_BK	Ergonomic Duty Belt Harness	Black	LG/XL/2XL

A close-up photograph of a person's hands holding a pair of tan tactical gloves. The person is wearing a dark grey or black jacket and blue denim jeans. The gloves are made of a textured material, possibly leather or a synthetic equivalent, and feature a small black and white logo on the wristband that reads "BLACKHAWK". The background is a blurred outdoor setting with gravel or dirt. The word "APPAREL" is superimposed in large, bold, white, sans-serif capital letters across the center of the image.

APPAREL

TACTICAL WATERPROOF JACKET

- Sizes: SM – 3XL
- Body: 90% Polyester / 10% Spandex
- Lining: 100% Polyester
- Mid-weight 3 layer, 4-way stretch fabrication
- Teflon™ Shield fabric protector repels stains, oil, and water
- Fully waterproof and seam sealed, yet breathable
- YKK® AquaGuard® waterproof zippers
- Articulated elbows for increased mobility
- Bartack reinforcements on all critical seams
- Adjustable storm cuffs
- 3-piece adjustable hood
- Right shoulder mic clip
- 2-way side seam quick draw holster zippers
- Right sleeve ID badge patch
- Internal Secure Pocketing: 2 document pockets, 1 media pocket
- External Secure Pocketing: 2 hand pockets, 2 left sleeve utility pockets, 1 chest pocket, 1 concealed kidney pocket



Part Number	Description	Color
JK01BLXX	Tactical Waterproof Jacket	Black
JK01NAXX	Tactical Waterproof Jacket	Navy
JK01SLXX	Tactical Waterproof Jacket	Slate

*To determine the Part #: The last 2 digits represent size code

RAID WINDBREAKER JACKET

- Sizes: SM – 3XL
- Body: 100% Polyester
- Windproof fabrication
- Highly water resistant DWR finish
- Packable design: packs into own left hand pocket
- Fully ventilated yoke for increased breathability
- Dual shoulder mic clips
- Adjustable, stowable hood
- 2-way side seam quick draw holster zippers
- 1 chest document pocket
- 2 zip secure hand pockets



Part Number	Description	Color
JK10BKXX	Raid Windbreaker Jacket	Black
JK10NAXX	Raid Windbreaker Jacket	Navy

*To determine the Part #: The last 2 digits represent size code

HEADWEAR

AGENCY PATCH CAP

- Sizes: OSFA
- Body: 100% washed cotton
- Hook and loop patch applique
- Adjustable closure

Part Number	Description	Color
EC01NAOS	Agency Patch Cap	Navy
EC01BKOS	Agency Patch Cap	Black
EC01JGOS	Agency Patch Cap	Jungle



TRIDENT FLEXFIT® CAP

- Sizes: OSFA
- Body: 63% Polyester / 34% Cotton / 3% PU Spandex
- Mesh: 95% Polyester / 5% PU Spandex
- Fully adjustable FlexFit elastic headband for maximum comfort
- No-Button crown for added comfort when worn with over-ear protection
- Leather patch Trident applique

Part Number	Description	Color
EC12GR0S	FlexFit Trident Cap	Graphite
EC12BM0S	FlexFit Trident Cap	Black MultiCam®



MICRO FLEECE BEANIE

- Sizes: OSFA
- Body: 100% Polyester
- Brushed micro fleece traps warmth while promoting moisture transport
- Moisture wicking mesh liner



Part Number	Description	Color
EB01BKOS	Micro Fleece Beanie	Black
EB01JGOS	Micro Fleece Beanie	Jungle
EB01SLOS	Micro Fleece Beanie	Slate

LIGHTWEIGHT NOMEX® BALACLAVA

- Sizes: OSFA
- 6-oz Nomex® material provides lightweight flash and flame resistance
- Internal flat-seam stitching reduces helmet irritation
- 18" head-to-neck coverage



Part Number	Description	Color	NSN#
333005BK	Lightweight Balaclava	Black	8415-01-591-9066
333005CT	Lightweight Balaclava	Coyote Tan	8415-01-613-1277
333005OD	Lightweight Balaclava	Olive Drab	

TACTICAL SHEMAGH

- Sizes: OSFA
- Dimensions: 44" x 44" (112 cm x 112 cm)
- Body: 100% Cotton
- Traditional desert headwear provides protection to the neck and head from the sun and debris



Part Number	Description	Color	NSN#
330005CT	Tactical Shemagh	Coyote Tan	8440-01-529-6427
330005OD	Tactical Shemagh	Olive Drab	8440-01-529-6429

8" DESERT OPS BOOT

- Rugged nylon and suede leather construction
- Vibram® Outsole with large, open lugs for maximum comfort and traction
- DRI-LEX® liner wicks away moisture to keep feet dry
- OrthoLite™ foam insoles are anti-microbial and machine washable
- Agion® scent-control finish on the liner mitigates foot odor
- Steel shank provides additional support when under load
- Fully gusseted tongue keeps out debris
- Abrasion resistant toe and heel reinforcements



SKU	Description	Color	Size
BT05CYXXXX	Desert Ops Boot	Coyote 498	4.5-6.5 M; 7-12 M; 13, 14 M

*To determine the Part #: The last 4 digits represent size code

6" TRIDENT ULTRALITE BOOT

- Lightweight 600 denier ballistic nylon and suede leather construction
- Phylon midsole provides superior lightweight cushioning
- OrthoLite™ foam insoles are anti-microbial and machine washable
- Agion® scent-control finish on the liner mitigates foot odor
- NATO speed lacing system



SKU	Description	Color	Size
BT06CYXXXX	Trident Ultralite	Coyote 498	4.5-6.5 M; 7-12 M;
BT06BKXXXX	Trident Ultralite	Black	4.5-6.5 M; 7-12 M;

*To determine the Part #: The last 4 digits represent size code

KNEE/ELBOW PADS

TRIDENT ELBOW PAD

- Sizes: OSFA
- 600 denier nylon carrier
- Injection molded FlexCap shell
- Closed cell, impact resistant foam padding
- Elastic straps for maximum mobility
- Strap retention loops
- QD hook and post closure system
- No slip tri-glide buckles for quick and easy adjustments



Part Number	Description	Color
EP03BKOS	Trident Elbow Pad	Black
EP03CTOS	Trident Elbow Pad	Coyote
EP03ODOS	Trident Elbow Pad	Olive Drab

TRIDENT KNEE PAD

- Sizes: OSFA
- 600 denier nylon carrier
- Injection molded FlexCap shell
- Closed cell foam padding
- Heavy duty elastic top strap for maximum mobility
- Static nylon bottom strap reduces slippage
- Strap retention loops



Part Number	Description	Color
KP03BKOS	Trident Knee Pad	Black
KP03CTOS	Trident Knee Pad	Coyote
KP03ODOS	Trident Knee Pad	Olive Drab

GLOVES

S.O.L.A.G.® STEALTH GLOVE

- Touch screen compatible for cell phones
- D30® impact foam protects knuckles
- Nomex® and Kevlar® protects hand from flash/flame and cuts
- Molded TPR hard knuckle cover

Part Number	Description	Color	Size
GT008BK	SOLAG Stealth Glove	Black	SM-2XL

*To determine the Part #: The 1st 5 digits are the style # (GT008) followed by the 2-digit color code (BK) and then followed by the size code or see a sales rep for a complete listing of style numbers. Example: GT008BKSM



S.O.L.A.G.® RECON GLOVE

- Touch screen compatible for cell phones
- D30® impact foam protects knuckles
- Nomex® and Kevlar® protects hand from flash/flame and cuts

Part Number	Description	Color	Size
GT007BK	SOLAG RECON glove	Black	SM-2XL
GT007TN	SOLAG RECON glove	Coyote 499	SM-2XL

*To determine the Part #: The 1st 5 digits are the style # (GT007) followed by the 2-digit color code (BK) and then followed by the size code or see a sales rep for a complete listing of style numbers. Example: GT007BKSM



S.O.L.A.G.® INSTINCT FULL GLOVE

- Touch screen compatible for cell phones
- D30® impact foam protects knuckles

Part Number	Description	Color	Size
GT006BK	SOLAG INSTINCT FULL Glove	Black	SM-2XL

*To determine the Part #: The 1st 5 digits are the style # (GT006) followed by the 2-digit color code (BK) and then followed by the size code or see a sales rep for a complete listing of style numbers. Example: GT006BKSM



S.O.L.A.G.® INSTINCT HALF GLOVE

- Half fingers for smooth/no catch finger grip
- D30® impact foam protects knuckles

Part Number	Description	Color	Size
GT005BK	SOLAG INSTINCT HALF Glove	Black	SM-2XL

*To determine the Part #: The 1st 5 digits are the style # (GT005) followed by the 2-digit color code (BK) and then followed by the size code or see a sales rep for a complete listing of style numbers. Example: GT005BKSM



A.V.I.A.T.O.R.® GLOVE

- Touch screen compatible for cell phones
- Nomex® construction resists flash and flame
- Seamless index finger for no-catch trigger finger

Part Number	Description	Color	Size
GT009BK	AVIATOR Glove	Black	SM-2XL
GT009TN	AVIATOR Glove	Coyote 499	SM-2XL

*To determine the Part #: The 1st 5 digits are the style # (GT009) followed by the 2-digit color code (BK) and then followed by the size code or see a sales rep for a complete listing of style numbers. Example: GT009BKSM



A.V.I.A.T.O.R.® COMMANDO

- Touch screen compatible for cell phones
- Nomex® construction resists flash and flame
- Seamless index finger for no catch trigger finger

Part Number	Description	Color	Size
GT003BK	AVIATOR COMMANDO Glove	Black	SM-2XL
GT003TN	AVIATOR COMMANDO Glove	Coyote 499	SM-2XL

*To determine the Part #: The 1st 5 digits are the style # (GT003) followed by the 2-digit color code (BK) and then followed by the size code or see a sales rep for a complete listing of style numbers. Example: GT003BKSM



A.V.I.A.T.O.R.® WINTER OPS GLOVE

- Touch screen compatible for cell phones
- Carabiner loop for easy storage/carry
- Insulated for cold ops

Part Number	Description	Color	Size
GP003BK	AVIATOR WINTER OPS Glove	Black	SM-2XL
GP003UG	AVIATOR WINTER OPS Glove	Urban Gray	SM-2XL

*To determine the Part #: The 1st 5 digits are the style # (GS001) followed by the 2-digit color code (BK) and then followed by the size code or see a sales rep for a complete listing of style numbers. Example: GS001BKSM



A.V.I.A.T.O.R.® APTITUDE GLOVE

- Insulation keeps cold air out
- Silicone grip print on palm for dexterity
- Fold-back finger tip for smooth, no catch trigger finger

Part Number	Description	Color	Size
GS001BK	AVIATOR APTITUDE Glove	Black	SM-2XL

*To determine the Part #: The 1st 5 digits are the style # (GS001) followed by the 2-digit color code (BK) and then followed by the size code or see a sales rep for a complete listing of style numbers. Example: GS001BKSM



P.A.T.R.O.L.® ELITE GLOVE

- Touch screen compatible for cell phones
- Embossed grip print on palm for dexterity
- Watch-compatible cuff for less bulk and easy read

Part Number	Description	Color	Size
GP002BK	PATROL ELITE Glove	Black	SM-2XL

*To determine the Part #: The 1st 5 digits are the style # (GP002) followed by the 2-digit color code (BK) and then followed by the size code or see a sales rep for a complete listing of style numbers. Example: G002BKSM



P.A.T.R.O.L.® BARRICADE GLOVE

- Touch screen compatible for cell phones
- Kevlar® construction resists cuts
- Compression-molded neoprene protects knuckles

Part Number	Description	Color	Size
GP001BK	PATROL BARRICADE Glove	Black	SM-2XL

*To determine the Part #: The 1st 5 digits are the style # (GP001) followed by the 2-digit color code (BK) and then followed by the size code or see a sales rep for a complete listing of style numbers. Example: GP001BKSM



F.U.R.Y.® PRIME GLOVE

- Touch screen compatible for cell phones
- Silicone grip print on palm for dexterity
- Sonic-welded, molded TPR protects back of hand

Part Number	Description	Color	Size
GT002BK	FURY PRIME Glove	Black	SM-2XL
GT002TN	FURY PRIME Glove	Coyote 499	SM-2XL
GT002BK	FURY PRIME Glove	Urban Gray	SM-2XL

*To determine the Part #: The 1st 5 digits are the style # (GT002) followed by the 2-digit color code (BK) and then followed by the size code or see a sales rep for a complete listing of style numbers. Example: GT002BKSM



F.U.R.Y.® UTILITARIAN GLOVE

- Touch screen compatible for cell phones
- Silicone grip print on palm for dexterity
- Breathable perforated palm for cooling

Part Number	Description	Color	Size
GT001BK	FURY UTILITARIAN Glove	Black	SM-2XL
GT001TN	FURY UTILITARIAN Glove	Coyote 499	SM-2XL
GT001UG	FURY UTILITARIAN Glove	Urban Gray	SM-2XL

*To determine the Part #: The 1st 5 digits are the style # (GT001) followed by the 2-digit color code (BK) and then followed by the size code or see a sales rep for a complete listing of style numbers. Example: GT001BKSM



A tan tactical backpack with an American flag patch is shown from a rear perspective, resting on a rocky surface. The scene is illuminated by the warm, low light of a sunset, creating a lens flare effect. The background is blurred, showing a rocky landscape under a bright sky.

BAGS + PACKS

MOBILE OPERATION BAG

- Constructed of 1000 denier nylon with reinforced stitching
- Full wraparound carry handles for superior weight support
- High-quality YKK® zippers with easy-grip pull tabs
- Two padded, detachable shoulder straps
- External lockdown zipper flap
- Heavy-duty D-rings for securing external items and shoulder straps
- Total: 24”L x 12”W x 9”D = 3,850 cu. in.
- One large pocket: 22”L x 10”W x 2”D
- Two small pockets: 10.5”L x 10”W x 2”D



Part Number	Description	Color
20MOB2BK	Mobile Operation Bag, MD	Black

CROWD CONTROL BAG

- Constructed of 1000 denier nylon with reinforced stitching
- Full wraparound carry handles for superior weight support
- Adjustable, removable shoulder strap
- High-quality YKK® zippers with easy-grip pull tabs
- Reinforced with polymer stiffeners
- ID panel on front pocket
- Padded helmet compartment
- External pouches and straps to secure baton or flashlight
- Dimensions: Total: 13”L x 11”W x 35”D = 5,005 cu. in.
- Main compartment: 21.5”L x 11”W x 13”D
- Helmet compartment: 13.5”L x 11”W x 13”D



Part Number	Description	Color
20CC00BK	Crowd Control Bag	Black

MOBILE OPERATION BAG

- Constructed of 1000 denier nylon with reinforced stitching
- Full wraparound carry handles for superior weight support
- High-quality YKK® zippers with easy-grip pull tabs
- Two padded, detachable shoulder straps
- External lockdown zipper flap
- Heavy-duty D-rings for securing external items and shoulder straps
- Dimensions: Total: 27”L x 14”W x 10”D = 5,500 cu. in.
- Large pocket: 24”L x 12”W x 3”D
- Two small pockets: 12”L x 12”W x 3”D



Part Number	Description	Color
20MOB3BK	Mobile Operation Bag, L	Black

POLICE EQUIPMENT BAG

- Constructed of 1000 denier nylon with reinforced stitching
- Full wraparound carry handles for superior weight support
- Reinforced with internal polymer stiffeners
- Adjustable, removable shoulder strap
- Heavy-duty lockable YKK® zippers with easy-grip pull tabs
- Fully padded lid
- Two external zippered pouches, three open-top pouches and two straps for batons or lights
- Two internal zippered pouches and pen holder slots
- Dimensions: Total: 7.5”L x 12”W x 18.5”D = 5,005 cu. in.
- Two external pouches: 8”L x 1”W x 5.5”D
- Two internal pouches: 5.5”L x 1”W x 4”D



Part Number	Description	Color
20PE00BK	Police Equipment Bag	Black

CZ GEAR BAG

- Constructed of 1000 denier nylon with reinforced stitching
- Full wraparound carry handles for superior weight support
- High-quality YKK® zippers with easy-grip pull tabs
- Adjustable shoulder strap with reversible, non-slip shoulder pad
- Dimensions: Total: 33.5”L x 16”W x 15”D = 8,040 cu. in.



Part Number	Description	Color	NSN#
20CZ00BK	CZ Gear Bag	Black	8465-01-517-6330

MEDIUM A.L.E.R.T.™ BAG

- Constructed of 1000 denier nylon with reinforced stitching
- Zippered mesh dividers in all compartments
- Top dual-access (from outside or inside) compartment
- External compression straps stabilize load
- Hideaway pull handle and full wraparound carry handles for superior weight support
- Heavy-duty lockable YKK® zippers with easy-grip pulls
- Durable in-line skate wheels and reinforced corners
- Padded top pockets fold flat when not in use
- Dimensions: Total: 30”L x 16”W x 14”D = 6,720 cu. in.



Part Number	Description	Color	NSN#
20L004BK	Medium A.L.E.R.T. Bag	Black	8460-01-529-5774

A.L.E.R.T.™ BAG

- Constructed of 1000 denier nylon with reinforced stitching
- Hideaway pull handle and full wraparound carry handles for superior weight support
- Heavy-duty lockable YKK® zippers with easy-grip pull tabs
- Large U-shaped, hinge-type lid for easy access
- Two padded end-cap handles for two-person carry
- Nine internal mesh pouches for gear storage
- Four clear ID insert pockets (two on top and one at each end)
- Reinforced corners and stiffeners on bottom
- Available with inline-skate wheels or soft bottom, backpack straps and no wheels
- Dimensions: Total: 43L" x 15"W x 13"D = 8,385 cu. in.



Part Number	Description	Color	NSN#
20L003BK	A.L.E.R.T. Bag w/ wheels	Black	8465-01-517-6319

ENHANCED TACTICAL ROPE BAG

- Constructed of Type 4 nylon webbing
- Holds up to 200 feet of rope (rope not included)
- Drawstring sleeve for full bag closure
- Drawstring pocket holds excess drawstring
- Quick-release buckle belt attachment
- Grommets on bottom of bag for drainage
- External pocket for carabiners
- Quick disconnect leg straps with high-visibility red pull tabs
- Dimensions: 22"L x 5.5"W x 8"D



Part Number	Description	Color
20TR03BK	Enhanced Tactical Rope Bag	Black

A.L.E.R.T.™ 5 BAG

- Constructed of 1000 denier nylon with reinforced stitching
- External compression straps stabilize load
- Hideaway pull handle and full wraparound carry handles for superior weight support
- Removable daisy-chain handle
- Large U-shaped, hinge-type lid for easy access
- Multiple heavy duty D-rings for securing external/internal items or palletizing
- Two padded end-cap handles for two-person carry
- Durable inline-skate wheels and reinforced corners and stiffeners on bottom
- Multiple rows of S.T.R.I.K.E.® webbing for attaching pouches or accessories
- Large 33" x 14" weapon sleeve with heavy padding to protect long guns
- Three external clear window pockets for manifesting, content inventory or identification
- Dimensions: Total: 35"L x 21.5"W x 17"D = 9,684.5 cu. in.
- Main compartment: 34"L x 18"W x 14"D = 8,568 cu. in.
- External compartment: 29"L x 11"W x 3.5"D = 1,116.5 cu. in.



Part Number	Description	Color
20L005BK	A.L.E.R.T. 5 Bag	Black

SPORTSTER® PISTOL RANGE BAG

- Constructed of tight-weave, heavyweight 600 denier polyester with thick PVC laminate for stability
- Dual-density foam with internal open-cell foam for protection and external closed-cell foam for impacts
- Main internal pocket with dual-slider opening for easy access to contents
- Two external slash pockets hold magazines and other small items
- Includes two flannel-lined rugs to protect handgun inside main compartment
- Multiple rows of S.T.R.I.K.E.® webbing for attaching pouches or accessories
- Dimensions: 16" L x 9" H x 8" D



Part Number	Description	Color
74RB02BK	Sportster Pistol Range Bag	Black

SPORTSTER® DELUXE RANGE BAG

- Removable gun rug pistol pouch with internal soft fabric to protect firearm
- Dual-density foam with internal open-cell foam for protection and external closed-cell foam for impacts
- Wraparound tactical web handles for superior weight support
- Heavy seam binding with two rows of locked stitching for durability
- Self-healing, heavy-duty, oversized coil zipper
- Integral pockets to hold two handguns
- Multiple internal pockets for organizing magazines or accessories
- Multiple rows of S.T.R.I.K.E.® webbing for attaching pouches or accessories
- Dimensions: 15" L x 11"H x 10"D



Part Number	Description	Color
74RB01BK	Sportster Deluxe Range Bag	Black

SPORTSTER® SHOOTER'S BAG

- Constructed of tight-weave, heavyweight 600 denier polyester with thick PVC laminate for stability
- Dual-density foam with internal open-cell foam for protection and external closed-cell foam for impacts
- Two large dual-zippered compartments and one slash pocket
- Two internal pockets hold two handguns
- Internal mag pockets hold magazines securely
- Multiple rows of S.T.R.I.K.E.® webbing for attaching pouches or accessories
- Dimensions: 13"L x 9"H x 4.5"D



Part Number	Description	Color
73SB00BK	Sportster Shooter's Bag	Black

3-DAY ASSAULT™ PACK



- Constructed of 1000 denier nylon with reinforced stitching
- Accommodates 100-oz. hydration reservoir
- Sleeping bag straps, padded shoulder straps and heavy-duty D-rings for securing external items
- High-quality YKK® zippers and easy-grip pull tabs
- Reinforced drag/carry handle
- Removable elasticized sternum strap with silent release buckle and padded waist belt
- IVS™ (Intercooler Venting System) back panel for ventilation
- Dimensions: Main compartment: 20”L x 13”W x 6”D
Front compartment: 14.5”L x 12.5”W x 2.5”D
- Cubes: 2,000 cu. in. / 37 L



Part Number	Description	Color	NSN#
603D00BK	3-Day Assault Pack	Black	8465-01-610-4226
603D00DE	3-Day Assault Pack	Desert Tan	

ULTRALIGHT 3-DAY ASSAULT PACK

- Constructed of lightweight, high-tenacity 210/330 denier nylon and 210 denier ripstop nylon (solid colors)
- Accommodates 100-oz. hydration reservoir
- High-quality YKK® zippers with easy-grip pull tabs
- Easy-access main compartment with front pocket and map pocket
- Multiple rows of S.T.R.I.K.E.® webbing for attaching pouches or accessories
- Four adjustable external compression straps accommodate various loadouts
- Five internal tie-down loops
- Padded shoulder straps and removable heavy duty waist belt
- Heavy-duty D-rings for securing external items
- Loop fastener on front for ID patch attachment
- Dimensions: Inner main compartment: 20”L x 13”W x 6”D
Top-front pocket: 14.5”L x 12.5”W x 2.5”D
- Cubes: 2,000 cu. in. / 37 L



Part Number	Description	Color
603D08BK	Ultralight 3-Day Assault Pack	Black
603D08CT	Ultralight 3-Day Assault Pack	Coyote Tan

SPECIAL OPERATIONS MEDICAL BACKPACK



- Constructed of 1000 denier nylon with reinforced stitching
- Accommodates 100-oz. hydration reservoir
- Heavy-duty lockable YKK® zippers with easy-grip pull tabs
- Contour-padded shoulder straps and waist belt
- Robust grab handle and metal grommet at bottom of pack for drainage
- Adjustable external compression straps accommodate various loadouts
- Internal pockets made of urethane-coated mesh
- Individual medical gear compartments
- Padded back and internal tri-fold flap

Dimensions: 18"L x 13"W x 7.5"D = 2,225 cu. in.



Part Number	Description	Color	NSN#
60MP00BK	Special Operations Medical Backpack	Black	6545-01-522-1016
60MP00OD	Special Operations Medical Backpack	Olive Drab	6545-01-522-1030
60MP00DE	Special Operations Medical Backpack	Desert Tan	6545-01-522-1017

S.T.O.M.P. II® MEDICAL COVERAGE PACK (JUMPABLE)



- Constructed of 1000 denier nylon with reinforced stitching
- Breathable closed-cell foam padding
- Accommodates two 100-oz. hydration reservoirs
- Webbing on underside for accessory packs or medic/sleeping rolls
- Adjustable shoulder straps, web belt and sternum strap
- Two robust grab handles and metal grommet at bottom of pack for drainage
- Adjustable external compression straps accommodate various loadouts
- Internal elastic stays and keepers
- External hook & loop strip
- Drop pouches with rigging for jumps
- Several flat netted zipper pockets
- Includes S.T.O.M.P.® Medical Pack Accessory Pouch with Red Handle and S.T.O.M.P.® Medical Pack Accessory Pouch with Blue Handle for storing medical supplies
- Dimensions: 20"L x 13"W x 6"D = 2,470 cu. in.



Part Number	Description	Color	NSN#
60MP01BK	S.T.O.M.P. II Medical Coverage Pack	Black	8465-01-555-4217
60MP01OD	S.T.O.M.P. II Medical Coverage Pack	Olive Drab	6545-01-522-1031
60MP01DE	S.T.O.M.P. II Medical Coverage Pack	Desert Tan	6545-01-522-1029

RAPIDFLEX™ MEDICAL LITTER

- Constructed of heavy-duty, impermeable PVC tarpaulin
- Rolls up into small bundle for easy storage and deployment
- Stabilizing torso strap is constructed of 2" nylon webbing and adjusts to 76" with side-release buckle
- Six durable 2" nylon web loop handles (two on each side and one drag handle at each end)
- Combined strength of all four handles exceeds 1700 lbs.
- Drag weight exceeds 1600 lbs.

Part Number	Description	Color	NSN#
20ML00BK	RapidFlex Medical Litter	Black	6530-01-573-9585

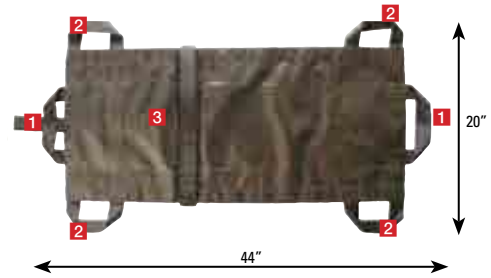

- 1 Reinforced top and bottom drag straps
- 2 Four side handles
- 3 Adjustable chest/waist straps
- 4 Adjustable leg straps

FAST ATTACK TACTICAL LITTER

- Heavy-duty, impermeable PVC tarpaulin material
- Six durable 2" nylon web loop handles (two handles on each side and one drag handle at each end)
- Combined strength of all four handles exceeds 1900 lbs.
- Drag weight exceeds 1800 lbs.
- Stabilizing torso strap constructed of 2" nylon webbing and adjusts to 76" with side-release buckle
- Angled stabilizing leg straps constructed of 2" nylon webbing and adjust to 32" with side-release buckles

Part Number	Description	Color	NSN#
20ML01BK	Fast Attack Tactical Litter	Black	6530-01-573-9600



MEDIC ROLL

- Constructed of durable 1000 denier nylon
- Full wraparound carry handles for superior weight support
- Internal pleated vinyl pockets to store medical supplies
- Dimensions: 37"L x 13.5"W

Part Number	Description	Color	NSN#
20EMR1BK	Medic Roll	Black	8465-01-594-0574



ACCESSORIES

SPEED CLIPS™

- Quickly and efficiently mount and disconnect pouches and other modular gear to any S.T.R.I.K.E.® or PALS/MOLLE platform.
- Eliminate tedious weaving and tested in combat
- Constructed of durable yet flexible polymer
- Designed to mount Speed Clip™ 3800 Series pouches to any S.T.R.I.K.E.® or PALS/MOLLE platform
- Multiple lengths span various widths of webbing to accommodate any size pouch
- # indicates how many widths are spanned
- Patent pending

Part Number	Description	Color
38C306BK	Speed Clips, six #3s	Black
38C306CT	Speed Clips, six #3s	Coyote Tan
38C306FG	Speed Clips, six #3s	Forest Green
38C306OD	Speed Clips, six #3s	Olive Drab
38C506BK	Speed Clips, six #5s	Black
38C506CT	Speed Clips, six #5s	Coyote Tan
38C506OD	Speed Clips, six #5s	Olive Drab
38C706BK	Speed Clips, six #7s	Black
38C706CT	Speed Clips, six #7s	Coyote Tan
38C706OD	Speed Clips, six #7s	Olive Drab
38C906BK	Speed Clips, six #9s	Black
38C906CT	Speed Clips, six #9s	Coyote Tan



BELT MOUNTED

BELT MOUNTED SINGLE PISTOL MAG POUCH

- BTS™ belt loop attachment system
- Constructed of 500 denier ripstop
- Horizontal and vertical 2" belt mount
- Compatible with both single- and double-stacked magazines
- Lid with hook & loop closure

Part Number	Description	Color
51PM02BK	Belt Mounted Single Mag	Black



NIGHT-OPS® FLASHLIGHT HOLDER WITH MOD-U-LOK™ PLATFORM



- Securely carry popular personal tactical lights with 1.25" diameter bezel and 1" diameter body
- Accommodates bezel-up or bezel-down carry
- Quick-disconnect belt loop with one-handed release
- Attach to belt without unthreading other gear
- Fits belts up to 2.25" wide
- Adjustable cant for mounting light at various angles



Mod-U-Lok™ Platform



Belt Mounted

Part Number	Description	Color
75GH00BK	Night-Ops® Flashlight Holder	Black

BELT MOUNTED DOUBLE HANDCUFF POUCH

- BTS™ belt loop attachment system
- Constructed of 500 denier ripstop
- Fits belts up to 2.5" wide
- Lid with hook & loop closure



Part Number	Description	Color
50HC01BK	Double Handcuff	Black

CASES

DISCREET SOCOM PISTOL CASE

- Fully modular pouches for custom configurations
- .375" closed-cell foam padding for weapon protection
- TalonFlex™ plastic inserts on top and bottom for stiffness
- High-quality YKK® zippers and dual sliders with full wraparound carry handles
- Universal holster and barrel pouch, sound suppressor pouch, double mag pouch and UTL light pouch
- Dimensions: 10"L x 13"W x 2.5"D



Part Number	Description	Color
66SS00BK	Discreet SOCOM Pistol Case	Black

/ HOLSTERS / DUTY + PROTECTIVE / APPAREL / BAGS + PACKS / ACCESSORIES /

GUN RUG PISTOL POUCH

- Constructed of 1000 denier nylon
- .375" closed-cell foam padding for weapon protection
- High-quality YKK® zippers and dual sliders for security and full wraparound carry handles
- Internal padded divider for weapons and accessories and elastic keeper for extra magazines
- Dimensions: 12"L x 8"W



Part Number	Description	Color	NSN#
61GR01BK	Gun Rug Pistol Pouch	Black	1095-01-517-6337

SPORTSTER® PISTOL RUG

- Constructed of tight-weave, heavyweight 600 denier polyester with thick PVC laminate for stability
- Dual-density foam with internal open-cell foam for protection and external closed-cell foam for impacts
- Internal soft fabric protects firearm finish
- Wraparound tactical web handles for superior weight support
- Rugged tactical webbing on shoulder straps and contact points
- Heavy seam binding with two rows of locked stitching for durability
- Self-healing, heavy-duty, oversized coil zippers
- Fits most pistols and revolvers
- Dimensions: Medium: 12.5"L x 8"W x 1.25"D (74PR01) Large: 15"L x 8"W x 1.25"D (74PR02)



Part Number	Description	Color	Size
74PR01BK	Sportster® Pistol Rug	Black	Medium
74PR02BK	Sportster® Pistol Rug	Black	Large

PADDED WEAPONS CASE

- Double-stitched seam taping on raw edges with Box X-anchor stitching on handles
- Lightweight closed-cell foam padding does not absorb moisture
- Full-opening zipper for shooting mat configuration
- Removable, adjustable shoulder strap with non-slip shoulder pad
- Internal divider to carry up to two weapons side by side
- Large external utility pouch secured by hook & loop



Part Number	Description	Color	Size	NSN#
61PW01BK	44" Padded Weapons Case	Black	44" x 3.5" x 14"	1095-01-517-7104

RIFLE CASE

- Padded .375" closed-cell foam absorbs shock but not water
- Double-stitched seam taping on raw edges with Box X-anchor stitching on handles
- Full-opening zipper for shooting mat configuration
- High-quality YKK® zippers and sliders
- Removable foam inserts and four external mag pouches with adjustable lids



Part Number	Description	Color	Size
64RC34BK	34" Rifle Case	Black	34" x 2.5" x 11.5"
64RC37BK	37" Rifle Case	Black	37" x 2.5" x 11.5"

SHOTGUN CASE

- Constructed of durable 1000 denier nylon and .375" closed-cell foam
- Removable, adjustable shoulder strap with non-slip shoulder pad
- Designed to hold standard stock 18" to 22" barrels
- High-quality YKK® zippers and sliders
- Dual-slider zippered utility pocket and pouches



Part Number	Description	Color	Size
64SG43BK	Shotgun Case	Black	43" x 2" x 8"

LONG GUN SNIPER DRAG BAG

- Constructed of durable 1000 denier nylon and closed-cell foam
- Full-opening zipper for shooting mat configuration
- High-quality YKK® zippers and sliders
- Detachable shoulder straps for muzzle-up or muzzle-down carry
- Reinforced drag handle and front/rear cargo pouches with internal straps
- Loops for ghillie attachment
- Internal weapon-securing straps and two internal utility pouches
- Dimensions: 51"L x 11"W x 3"D
 - Rear cargo pouch: 9.5"L x 12"W x 2"D
 - Front cargo pouch: 23"L x 8.5"W x 2"D



Part Number	Description	Color	Size
20DB01BK	Sniper Drag Bag	Black	51"
20DB01OD	Sniper Drag Bag	Olive	51"
20DB01DE	Sniper Drag Bag	Tan	51"

STALKER DRAG MAT

- Constructed of durable 1000 denier nylon and closed-cell foam
- Removable, adjustable shoulder strap with non-slip shoulder pad
- Internal weapon-securing straps
- Elastic loops with protective flap hold 10 rounds of .308 ammo
- Internal data book pocket and open bottom design
- Dimensions: Closed 50.5”L x 9”W x 2”D

Part Number	Description	Color	Size	NSN#
80DM00BK	Stalker Drag Mat	Black	50.5” x 32”	8465-01-517-7048
80DM00OD	Stalker Drag Mat	Olive	50.5” x 32”	8465-01-517-7049



PRO-SHOOTERS MAT

- Constructed of durable 1000 denier nylon and closed-cell foam
- Hydration-compatible pouch with tube-routing system
- Removable, adjustable shoulder strap with non-slip shoulder pad and heavy-duty carry handle
- Non-slip shooting surface
- Dimensions: Closed 28”L x 8” Diameter

Part Number	Description	Color	Size	NSN#
80CM00OD	Pro-Shooters Mat	Olive	83” x 28”	8465-01-517-7050
80CM00DE	Pro-Shooters Mat	Tan	83” x 28”	



SPORTSTER® TACTICAL CARBINE CASE

- Tight-weave 600 denier polyester with thick PVC laminate and dual-density foam padding
- Holds carbines up to 36” long
- Four external mag pockets and two large accessory pockets for gear

Part Number	Description	Color	Size
74SG36BK	Sportster Tactical Carbine Case	Black	36” x 11.5” x 3”



SPORTSTER® SHOTGUN CASE

- Tight-weave 600 denier polyester with thick PVC laminate and dual-density foam padding
- Holds shotguns up to 52" long
- Multiple rows of S.T.R.I.K.E.® webbing for attaching pouches or accessories



Part Number	Description	Color	Size
74SG01BK	Sportster Shotgun Case	Black	53" x 8" x 2"

SPORTSTER® TACTICAL RIFLE CASE

- Tight-weave 600 denier polyester with thick PVC laminate and dual-density foam padding
- Holds rifles up to 42.5" long (74SG02) or 44" long (74SG03)
- Five external mag pockets and two large accessory pockets for gear



Part Number	Description	Color	Size
74SG02BK	Sportster Tactical Rifle Case-Small	Black	42.5" x 11.5" x 3"
74SG03BK	Sportster Tactical Rifle Case-Large	Black	44" x 12.5" x 3"

SPORTSTER® SCOPED RIFLE CASE

- Tight-weave 600 denier polyester with thick PVC laminate and dual-density foam padding
- Holds scoped rifles up to 44" long (74SG44) or 48" long (74SG48)
- Multiple rows of S.T.R.I.K.E.® webbing for attaching pouches or accessories



Part Number	Description	Color	Size
74SG44BK	44" Sportster Scoped Rifle Case	Black	45" x 10" x 2"
74SG48BK	48" Sportster Scoped Rifle Case	Black	51.5" x 10" x 2"

SPORTSTER® MODULAR WEAPONS CASE

- Tight-weave 600 denier polyester with thick PVC laminate and dual-density foam padding
- Modular discreet case with removable divider
- Internal S.T.R.I.K.E.® webbing for attaching pouches or accessories
- Includes Muzzle Retainer and Weapon Retainer



Part Number	Description	Color	Size
74SG04BK	Sportster Modular Weapons Case	Black	36" x 13" x 5"

A collection of tactical accessories is displayed on a dark, textured surface. In the foreground, a black flashlight with a tan grip is prominent. Behind it, a black magazine and a black holster are visible. The word "ACCESSORIES" is overlaid in large, bold, white capital letters across the center of the image.

ACCESSORIES

MULTIPOINT SLING



Quick Disconnect



Snap Hook



Free End

- Nylon weave construction designed for long hours of wear
- Quickly converts to multiple configurations with only one hand
- Rapid Adjustment Slider Buckle enables high-speed rifle transitions
- All-steel quick detach mounting points are built to last

Part Number	Description	Color
70MCFE05BK	Multi-Point Sling - Cushion Stretch Slick	Black
70MCFE05CT	Multi-Point Sling - Cushion Stretch Slick	Coyote Tan
70MQD01BK	Multi-Point Sling - QD Slick	Black
70MQD01CT	Multi-Point Sling - QD Slick	Coyote Tan
70MQDS02BK	Multi-Point Sling - QD Stretch	Black



Quick Disconnect Slick



Snap Hook Stretch



Quick Disconnect Stretch



Free End Slick

METAL 1" HEAVY-DUTY SNAP HOOKS

- Robust construction
- Set of two

Part Number	Description	Color
98HM00BK	Metal 1" Heavy-Duty Snap Hooks	Black



UNIVERSAL SINGLE-POINT SLING ADAPTER



- Ambidextrous design
- Firearm hangs flat against body
- Compatible with most conventional sling hooks
- Fits AR15/M4/M16 collapsible stocks (not compatible with some Colt rifles)

Part Number	Description	Color	NSN#
70SM04BK	Universal Single-Point Sling Adapter	Black	1005-01-533-3432



SINGLE-POINT SLING ADAPTER

- Constructed of heavy-duty nylon webbing with robust metal D-rings
- Configures any weapon to accept a single-point sling

Part Number	Description	Color	NSN#
70SA00BK	Single-Point Sling Adapter	Black	1005-01-589-9506



AR-15/M4 STORM™ SLING ADAPTER



- For use with AR-15/M4 rifles equipped with collapsible stocks
- Provides ambidextrous mounting points for STORM Slings™
- Simple add-on installation with no modification required
- Fits MIL-spec or commercial tubes

Part Number	Description	Color
71SA05BK	AR-15/M4 STORM Sling Adapter	Black



RAIL MOUNT SLING ADAPTER



- Constructed of 6061 T6 aluminum with matte Type-III hard-coat anodized finish
- Mounting screw threads into steel insert for additional strength
- Works with snap hooks, MASH clip, wire loops, push-button swivels or sling webbing (up to 1.25" wide)
- Limited rotation push button swivel socket prevents twisted slings

Part Number	Description	Color
71SA00BK	Rail Mount Sling Adapter	Black



UNIVERSAL SWIFT SLING



- Three-point sling features a quick cam buckle for rapid one-hand adjustment
- Constructed of high-quality 1.25" nylon webbing
- Heavy duty tri-glide buckle, metal ring and single side-release buckle for quick detachment
- Adjustable, ambidextrous design for 60 possible configurations and quick shoulder transitions

Part Number	Description	Color
70GS17BK	Universal Swift Sling	Black
70GS17MC	Universal Swift Sling	Multicam®



STORM™ SLING RS



- Constructed of high-quality 1.25" nylon webbing
- High-strength, smooth elliptical bungee for improved firearm agility and CQB tactics
- Rapid-release buckle for easy and safe sling removal
- Removable forged snap hook for quick and positive firearm attachment
- Integrated release buckle for convenient firearm attachment or removal
- Heavy-duty tri-glide buckle for proper fit



Part Number	Description	Color
70GS20BK	STORM Sling RS	Black
70GS20MC	STORM Sling RS	Multicam®

STORM™ SLING



- Single-point sling is constructed of high-strength 1.25" wide nylon webbing with an elliptical bungee
- Compressed tubular nylon sheathing limits bounce and enhances retention
- Elastic-encased MASH clip for quick, positive firearm attachment
- Heavy-duty tri-glide buckle, metal ring and single side-release buckle for quick attachment
- 4" flex for weapon agility and CQB tactics
- Adjusts from 46" to 64" in diameter to fit all body sizes and around bulky tactical vests or gear



Part Number	Description	Color	NSN#
70GS12BK	STORM Sling	Black	1005-01-533-3425

STORM™ SLING QD



- Single-point sling adjusts from 30" to 50"
- Removable, elastic-encased MASH clip for quick, positive firearm attachment
- Robust bar tacking and box stitching for maximum strength
- Constructed of high-quality 1.25" wide nylon webbing
- Heavy-duty tri-glide buckle, metal ring and side-release buckle for quick firearm attachment



Part Number	Description	Color
70GS15BK	STORM Sling QD	Black

STORM™ SLING XT



- Single-point sling adjusts from 46" to 64" in diameter to fit all body sizes and around bulky vests or gear
- Elliptical bungee provides comfort and support
- Compressed tubular nylon sheathing limits bounce and enhances retention
- Constructed of high-quality 1.25" wide nylon webbing
- Removable, elastic-encased MASH clip for quick, positive firearm attachment
- Heavy-duty tri-glide buckle, metal ring and side-release buckle for quick firearm attachment
- 4" flex for weapon agility and CQB tactics
- Robust bar tacking and box stitching for maximum strength



Part Number	Description	Color	NSN#
70GS16BK	STORM Sling XT	Black	1005-01-581-6896
70GS16CT	STORM Sling XT	Coyote Tan	
70GS16MC	STORM Sling XT	MultiCam®	

STORM™ SLING XT/QD AND SUB-GUN SLING QUICK DISCONNECT ATTACHMENT



- Extra attachment assembly for multiple firearms



Part Number	Description	Color
70SA02BK	Sling Quick Disconnect Attachment	Black

QD SWIVEL SLING ADAPTER



- Heavy-duty QD swivel
- Compatible with STORM™ Sling RS, QD, XT and Sub-Gun Sling



Part Number	Description	Color
70SA03BK	QD Swivel Sling Adapter	Black

DIETER CQD SLING WITH SLING COVER

- Hybrid single-point/two-point sling incorporates heavy duty elastic
- Constructed of 1.25" wide T-13 webbing that is softer than standard webbing
- Adjustable design to fit all operators
- Metal snap hooks attach to most weapon systems, brackets or attachment buckles



Part Number	Description	Color	NSN#
71CQS1BK	Dieter CQD Sling with Sling Cover	Black	8415-01-504-3087

TACTICAL RELEASABLE S.T.R.I.K.E.® SLING



- Heavy-duty elliptical bungee and tubular nylon webbing design is fully adjustable
- Metal snap hook at each end for attachment to most weapon systems, brackets, buckles or webbing
- Adjustable design to fit all operators
- Side-release buckle for quick firearm attachment and removal
- Secure three-point cop-lock buckle in the middle for easy weapon removal from attaching point on vest



Part Number	Description	Color	NSN#
70GS13BK	Tactical Releasable S.T.R.I.K.E. Sling	Black	1095-01-554-0505

UNIVERSAL TACTICAL 1.25" SLING



- Fully-adjustable and ambidextrous two-point design

Part Number	Description	Color
70UT00BK	Universal Tactical 1.25" Sling	Black



SHOTGUN SHELL SLING



- Adjustable two-point design constructed of high-quality 2" wide nylon webbing
- Elastic strap holds 15 extra shells
- Attaches to standard sling swivels with durable steel spring hooks



Part Number	Description	Color	NSN#
43SS15BK	Shotgun Shell Sling	Black	1398-01-520-7279

KUDU STRETCH SLING



- Constructed of high-quality 2" wide elastic webbing with non-slip rubber ribs
- Fully adjustable length to fit all body sizes
- Compatible with a wide variety of rifles and shotguns
- Includes two 1" LOK-DOWN™ swivels

Part Number	Description	Color
73KS01BK	Kudu Stretch Sling	Black



MOUNTAIN SLING



- Constructed of high-quality 1.25" wide nylon webbing
- Non-slip backing keeps sling in place
- Two all-steel, blued LOK-DOWN™ swivels for easy attachment
- One-hand operation



Part Number	Description	Color
73SM00BK	Mountain Sling	Black

CQD® MARK III™ STEALTH WEAPONS CATCH

- Ultra-quiet with no hook & loop or snaps
- Robust spring-steel catch guarantees years of reliable performance
- Ambidextrous design
- Adjustable, removable elastic weapon retention strap
- Secures shotguns, rifles, less-than-lethal weapons and manual entry tools
- Includes two Speed Clips™ for S.T.R.I.K.E.® webbing attachment and two metal ALICE Clips for belt mounting



Part Number	Description	Color
71WC00BK	CQD Mark III Stealth Weapons Catch	Black
71WC00CT	CQD Mark III Stealth Weapons Catch	Coyote Tan

SHOTGUN BANDOLEER

- Constructed of high-quality 2.25" military belt nylon webbing and heavy-duty 1.5" elastic
- Holds 55 shotgun shells securely



Part Number	Description	Color
43SB55BK	Shotgun Bandoleer	Black

CQD® MARK II™ WEAPONS CATCHES

- Secure rifles, shotguns, sub-machine guns, tear gas launchers, non-lethal weapons and entry tools
- Offers a quick catch for moderate activity or quick response and a retention catch
- Adjustable retaining strap for various weapons
- Ambidextrous and compact (one size fits all)
- Compatible with existing equipment systems
- Version includes polymer hook for fast clip action and silent operation



Part Number	Description	Color	NSN#
71CQD2BK	Mark II Weapons Catches	Black	8465-01-491-4509

BUTTSTOCK SHOTGUN SHELL POUCH

- Fully ambidextrous design
- Constructed of lightweight nylon ripstop (pouch and lid)
- Shells are secured by elastic and protected by pouch and cover flap with hook & loop closure
- Holds five 2.25" or 3" shells
- Dual holding points for security



Part Number	Description	Color
52BS02BK	Buttstock Shotgun Shell Pouch	Black

M4 COLLAPSIBLE STOCK MAG POUCH

- Constructed of lightweight nylon ripstop
- Fits most collapsible stock designs
- Adjustable lid for 20- or 30-round magazines



Part Number	Description	Color	NSN#
52BS17BK	M4 Collapsible Stock Mag Pouch	Black	8465-01-514-8975

BUTTSTOCK MAGAZINE POUCH

- Constructed of lightweight 500 denier ripstop
- Compatible with all standard fixed buttstocks, most rifle magazines and most collapsible stock designs
- Adjustable lid accommodates 20-round or 30-round magazines
- Elastic forward-slip protection strap on back
- Adjustable straps for secure hold



Part Number	Description	Color	NSN#
52BS16BK	Buttstock Magazine Pouch	Black	8465-01-514-8974

TACTICAL CHEEK PAD

- Non-slip material for positive cheek weld
- Height-adjustable inserts
- Adjustable straps with end retaining strap to prevent forward slip

Part Number	Description	Color
90CP01BK	Tactical Cheek Pad	Black



RIFLE CHEEK PAD

- Constructed of 1000 denier nylon and closed-cell foam
- Aids eye relief efficiency, prevents slipping and reduces recoil to neck and cheek
- Adjustable tie-down system fits most rifle stocks
- Patent D490494

Part Number	Description	Color	NSN#
90CP00BK	Rifle Cheek Pad	Black	1005-01-517-7052



AMMO CHEEK PAD

- Constructed of 1000 denier nylon
- Non-slip material for positive cheek weld
- Allows for quick reload and instant visual of ammo status
- Zippered utility pouch and external ammunition storage

Part Number	Description	Color	NSN#
90CP02BK	Ammo Cheek Pad	Black	1005-01-517-7051



URBAN WARFARE IVS™ PERFORMANCE VENTILATING CHEEK PAD

- IVS™ compression-molded technology for enhanced performance
- Optimizes cheek weld, eye relief and ventilation for extended use
- Raises comb height for improved alignment with large tactical scopes
- Zippered utility pouch and external ammunition storage

Part Number	Description	Color
90CP05BK	Urban Warfare IVS™ Performance Ventilating Cheek Pad	Black
90CP05CT	Urban Warfare IVS™ Performance Ventilating Cheek Pad	Coyote Tan
90CP05MC	Urban Warfare IVS™ Performance Ventilating Cheek Pad	Multicam
90CP05OD	Urban Warfare IVS™ Performance Ventilating Cheek Pad	Olive Drab



OFFSET FLASHLIGHT RAIL MOUNT



- Constructed of 6061 T6 aluminum with Type-III hard-coat anodized finish
- For mounting flashlights to Picatinny spec rails
- Offset design for optimal positioning
- Compatible with 1" body flashlights
- Weighs 1.5oz

Part Number	Description	Color
71RM01BK	Offset Flashlight Rail Mount	Black



BUTTSTOCK SHELL HOLDER (OPEN)



- Open style elastic sleeve slips over rifle or shotgun stock for quick ammo access
- Sewn-on elastic loops keep ammo in place
- Rifle model includes nine ammo loops
- Shotgun model includes five ammo loops



Part Number	Description	Color
74SH00BK	Rifle Buttstock Shell Holder	Black
74SH02BK	Shotgun Buttstock Shell Holder	Black

ON-GUN COMPONENTS



KNOXX® AXIOM™ ULTRA-LIGHT RIFLE STOCK



- Fiberglass-reinforced polymer and alloy construction with aluminum pillars weighs only 2 lbs., 9 oz.
- Dual recoil-compensation systems reduce harsh recoil
- Rapid-adjust, five-position stock to fit all shooters (11.25" to 15.25" length-of-pull)
- Patented Recoil Reducing Technology

Part Number	Description	Color
K97000-C	Rem 700 BDL SA	Black
K97001-C	Rem 700 BDL LA	Black
K97501-C	Weatherby® Vanguard/Howa 1500 LA	Black

KNOXX® AXIOM™ R/F RUGER® 10/22® RIFLE STOCK



- Designed specifically for Ruger 10/22 rifles
- Includes all standard Knox® rifle stock features
- No recoil-compensation systems
- Rapid-adjust, six-position stock to fit all shooters (9.75" to 13.5" length-of-pull)
- Compatible with bipods



CT - Military/LE Only
NY - Not for Sale

Part Number	Description	Color
K98200-C	Knox Axiom R/F Ruger 10/22 Stock	Black
K98202-C	Knox Axiom R/F Ruger 10/22 Stock	Coyote Tan

KNOXX® SPECOPS STOCK GEN III™



- Reduces felt recoil by up to 80 percent
- Adjusts to six different positions to adapt to any shooter
- Buttstock tensioner removes rattle
- Multiple ambidextrous sling mounting locations
- Easy installation



Part Number	Description	Color
K38701-C	Rem 870	Black
K35001-C	Mossberg® 500	Black

KNOXX® SPECOPS STOCK GEN III™ (SHOTGUN)



- Reduces felt recoil by up to 80 percent
- Adjusts to six different positions to adapt to any shooter
- Buttstock tensioner removes rattle
- Multiple ambidextrous sling mounting locations
- Easy installation



Part Number	Description	Color
K38701-C	Rem 870	Black
K07200-C	Mossberg® 500	Black

KNOXX® AXION A-FRAME™ CARBINE STOCK



- Proprietary butt pad offers smooth shooting experience
- Portable multiple integrated QD Sling Mount for quick, easy sling attachment
- Customizable forward LOP adjustment cam and integrated fit, adjustment screw for custom setup

Part Number	Description	Color
KAR011BK	Knox A-Frame Carbine Stock	Milspec Tube - Black
KAR011GY	Knox A-Frame Carbine Stock	Milspec Tube - Gray
KAR011DK	Knox A-Frame Carbine Stock	Milspec Tube - Dark Earth
KAR011OD	Knox A-Frame Carbine Stock	Milspec Tube - Olive Drab



KNOXX® BREACHERS GRIP™



- Single recoil-compensation system reduces felt recoil
- Ergonomic pistol grip with integrated non-slip texturing
- Comfortable one-handed operation
- Compact design for easy storage
- Patented Recoil Reducing Technology



Part Number	Description	Color
K02200-C	Mossberg® 12 Gauge (Models 500, 535, 590, 835, 88)	Black

KNOXX® BREACHERS GRIP™ GEN III (SHOTGUN)



- Recoil reduction, patent pending design mitigates recoil on heavy shotgun loads
- Ergonomic comfort and control in any environment
- Integrated push-button sling mount

Part Number	Description	Color
K38702-C	Knox Breachers Grip™ Gen III Remington 870	Black
K35002-C	Knox Breachers Grip™ Gen III Mossberg 500	Black



RAIL MOUNT VERTICAL GRIP



- Molded of high-performance, fiberglass-reinforced polymer
- Redundant clamp screws for secure, reliable mounting and an adjustable fit for out-of-spec rails
- Two different caps (included) for custom length
- O-ring sealed compartment for tools, batteries, etc.
- 3" length and 3.0oz weight for short grip, 4.5" length and 4.1oz weight for long grip

Part Number	Description	Color
71VG00BK	Rail Mount Vertical Grip	Black

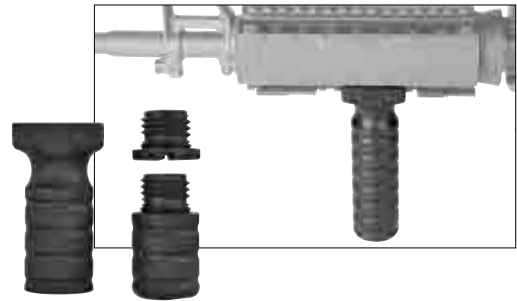

CT - Military/LE Only
NY - Not for Sale

KNOXX® AR PISTOL GRIP



- Better ergonomics, improved grip angle and palm swell offer a natural, intuitive feel
- Tactile textured gripping surface for maximum stability in any environment
- Color options include black, grey, dark earth and olive drab to allow customization for all AR set ups

Part Number	Description	Color
KARPG1BK	Knox AR Pistol Grip	Black



AR-15 NO-LATCH CHARGING HANDLE



- Latch-less design improves reliability, ambidextrous manipulation and shooting performance
- Molded oversize handle offers smooth operation, even while wearing gloves
- Light, strong machined 7075-Aluminum frame and over-molded polymer handle for optimal strength-to-weight ratio

Part Number	Description	Color
71CH00BK	AR-15 No-Latch Charging Handle	Black
71CH00DK	AR-15 No-Latch Charging Handle	Dark Earth



/ HOLSTERS / DUTY + PROTECTIVE / APPAREL / BAGS + PACKS / ACCESSORIES /

HYBRID FOLDING SIGHT

- Hybrid construction features solid metal alloy core with advanced co-polymer jacket that eliminates excess bulk.
- Flips up with a gloved hand, holds tight under .308 recoil.
- Tool-less windage and elevation adjustment dials and steel A2 front sight post aid accurate shot placement.
- Rear sight aligns to the M4/AR15 A-frame front sight height.



Part Number	Description	Color
71BU04XX	Hybrid Folding Sights - Rear	Black (BK) or Dark Earth (DK)
71BU05XX	Hybrid Folding Sights - Pair	Black (BK) or Dark Earth (DK)

To determine the Part #: The 1st 6 digits are the style # (71BU03) followed by the 2-digit color code (BK) . Example: 71BU03BK. Color codes: Black = BK; Flat Dark Earth = DK.

LOK-DOWN™ SWIVEL SET

- Includes two detachable swivels
- Positive locking mechanism



Part Number	Description	Color
70SW07BK	LOK-DOWN Swivel Set 1"	Blued
70SW08BK	LOK-DOWN Swivel Set 1.25"	Blued

SWIVEL STUD PICATINNY RAIL ADAPTER

- Constructed of rugged 6061 T6 aluminum with Type-III hard-coat anodized finish
- Provides Picatinny rail section for rail-mounted accessories
- Contains side swivel stud for continued use of sling
- Mounts to existing rifle swivel stud
- Weighs 1.7oz

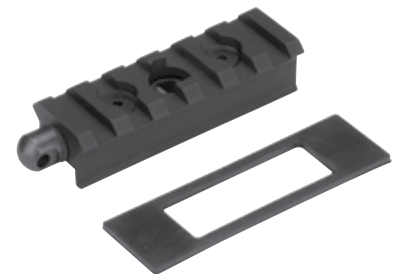

Part Number	Description	Color
71RA00BK	Swivel Stud Picatinny Rail Adapter	Black

HEAVY DUTY PUSH BUTTON SLING SWIVEL



- Constructed of quality materials with durable manganese phosphate finish
- Allows operator to quickly attach/detach sling from the weapon
- Compatible with most push-button swivel mounting points



Part Number	Description	Color
71SS00BK	Heavy Duty Push Button Sling Swivel	Black

SPORTSTER™ BIPOD

- Compact and lightweight design
- No-rust anodized legs with increased spring tension
- Spring-return telescoping legs
- Unshakable prone and bench shooting
- Easily attaches to sling swivel



Part Number	Description	Color	Size
71BP03BK	Sportster Bipod	Black	6" - 9"
71BP02BK	Sportster Bipod	Black	9" - 13"

SPORTSTER™ TRAVERSE TRACK™ BIPOD



- Durable all-metal construction with robust tubular legs
- Horizontal traverse for smooth target acquisition and tracking
- Pivot action for level shooting on uneven terrain
- Rapid-adjust lever lock
- Spring-return telescoping legs
- Easily attaches to sling swivel stud



Part Number	Description	Color	Size
71BP09BK	TraverseTrack Bipod	Black	6"-9"
71BP10BK	TraverseTrack Bipod	Black	9"-13"
71BP11BK	TraverseTrack Bipod	Black	13.5"-23"
71BP16BK	TraverseTrack Bipod	Black	14.5"-29.25"

SPORTSTER™ PIVOT BIPOD

- Compact and lightweight design
- Pivot eliminates rifle canting on uneven terrain
- Rapid-adjust pivot lever
- No-rust anodized legs with increased spring tension
- Spring-return telescoping legs
- Unshakable prone and bench shooting
- Easily attaches to sling swivel

Part Number	Description	Color	Size
71BP05BK	Sportster Pivot Bipod	Black	6"-9"
71BP06BK	Sportster Pivot Bipod	Black	9"-13"
71BP07BK	Sportster Pivot Bipod	Black	13.5"-23"
71BP08BK	Sportster Pivot Bipod	Black	14.5"-29.25"



CQD™ MARK I™ TYPE E MANUAL FOLDER

- Integrated button-lock, secondary safety, recessed belt/cord cutter and carbide glass breaker
- Blade length is 3.75"/95mm; Overall length is 9.5"/241 mm
- AUS8A stainless steel blade with black PVD coating
- Edge is partially serrated
- Injection-molded, reinforced nylon handle with 420J stainless steel liners
- Pocket clip for right- or left-side, tip-down carry
- High-visibility yellow handle available for first responders

Part Number	Description	Color
15M111BK	CQD™ Mark I™ Type E Manual Folder Serrated	Black



HAWKHOOK™



- Blade locks open via a stout frame-lock mechanism in the handle
- Lanyard hole, glass breaker, wire stripper, bottle opener and flat screwdriver/pry tip
- Recessed seat belt/cord cutter and ambidextrous thumb stud
- Blade length is 2.25"/57mm; Overall length is 5.5"/140mm
- AUS8A stainless steel blade with matte bead-blast finish
- Combination plain/partially serrated edge
- 420J stainless steel handle with textured nylon scale
- Pocket clip for right-side, tip-down carry

Part Number	Description	Color
15HH11SL	HawkHook	Silver



POUCHES

SIDE HYDRATION POUCH

- Mount on side, back, front or backpack using Speed Clips™
- Drink system protected by Microban® antimicrobial technology
- Bite valve and patent-pending quick-disconnect system
- Capacity is 40 oz./1 L
- Dimensions: 10”H x 7”W x 1.5”D

Part Number	Description	Color
65SH00BK	Side Hydration Pouch	Black
65SH00CT	Side Hydration Pouch	Coyote Tan



VEHICLE QD MEDICAL POUCH

- Mounts to most automobile headrests and some visors
- Quick detach feature allows instant removal from stowed position
- Red zipper pulls and grab handle identify the contents as medical supplies
- Loop panel on front of pouch allows attachment of additional hook back ID patches
- Made of high-quality materials such as 500 denier nylon and YKK® zippers

Part Number	Description	Color
20VP00BK	Vehicle QD Medical Pouch	Black



DOUBLE PISTOL MAG POUCH

- Hook & loop attachment
- Constructed of 500 denier ripstop (solid colors) or CORDURA® nylon (MultiCam®)

Part Number	Description	Color
61ACDMBK	Hook Backed Double Pistol Mag	Black



M16 MAG POUCH (HOLDS 2)

- Hook & loop attachment
- Constructed of 500 denier nylon
- Holds two 20- or 30-round magazines
- Reinforced bottom with metal grommets for drainage
- Adjustable lid accommodates various length magazines

Part Number	Description	Color
52HB00CT	Hook Backed Triple M16	Black



TRIPLE M16 MAG POUCH (HOLDS 3)

- Hook & loop attachment
- Holds three M16 magazines
- Constructed of 500 denier ripstop

Part Number	Description	Color
65MV01BK	Hook Backed Triple M16	Black



PISTOL MAG POUCHES

SINGLE PISTOL MAG POUCH

Part Number	Description	Color
MOLLE		
37CL06BK	S.T.R.I.K.E. Single Pistol Mag	Black
37CL06CT	S.T.R.I.K.E. Single Pistol Mag	Coyote Tan



DOUBLE PISTOL MAG POUCH

Part Number	Description	Color	NSN#
MOLLE			
37CL09BK	S.T.R.I.K.E. Double Pistol Mag	Black	8465-01-560-7829
37CL09CT	S.T.R.I.K.E. Double Pistol Mag	Coyote Tan	8465-01-554-2836
37CL09MC	S.T.R.I.K.E. Double Pistol Mag	MultiCam®	
37CL09OD	S.T.R.I.K.E. Double Pistol Mag	Olive Drab	8465-01-550-8988
37CL09RG	S.T.R.I.K.E. Double Pistol Mag	Ranger Green	
37CL09UG	S.T.R.I.K.E. Double Pistol Mag	Urban Grey	
USA MOLLE			
39CL09BK-USA	S.T.R.I.K.E. Double Pistol Mag	Black	
39CL09MC-USA	S.T.R.I.K.E. Double Pistol Mag	MultiCam®	



DOUBLE PISTOL MAG POUCH WITH TALONFLEX

Part Number	Description	Color
37CL10BK	Double Pistol Magazine Pouch with Talon Flex	Black
37CL10CT	Double Pistol Magazine Pouch with Talon Flex	Coyote Tan



M4/M16 POUCHES

M4/M16 SINGLE MAG POUCH (HOLDS 1)

Part Number	Description	Color
MOLLE		
37CL68BK	S.T.R.I.K.E. Single M4/M16 Mag	Black
37CL68CT	S.T.R.I.K.E. Single M4/M16 Mag	Coyote Tan
37CL68MC	S.T.R.I.K.E. Single M4/M16 Mag	MultiCam®
37CL68OD	S.T.R.I.K.E. Single M4/M16 Mag	Olive Drab



M4/M16 SINGLE MAG POUCH (HOLDS 2)

Part Number	Description	Color
MOLLE		
37CL02BK	S.T.R.I.K.E. M4/M16 Double Mag Holds 2	Black
USA MOLLE		
37CL02MC	S.T.R.I.K.E. M4/M16 Double Mag Holds 2	MultiCam®
37CL020D	S.T.R.I.K.E. M4/M16 Double Mag Holds 2	Olive Drab



M4/M16 STAGGERED MAG POUCH (HOLDS 2)

Part Number	Description	Color	NSN#
MOLLE			
37CL65BK	S.T.R.I.K.E. M4/M16 Staggered Mag	Black	
37CL65CT	S.T.R.I.K.E. M4/M16 Staggered Mag	Coyote Tan	8465-01-533-3007
37CL65MC	S.T.R.I.K.E. M4/M16 Staggered Mag	MultiCam®	
37CL650D	S.T.R.I.K.E. M4/M16 Staggered Mag	Olive Drab	



M4/M16 TRIPLE MAG POUCH (HOLDS 6)

Part Number	Description	Color
MOLLE		
37CL04BK	S.T.R.I.K.E. M4/M16 Triple Mag	Black
37CL04CT	S.T.R.I.K.E. M4/M16 Triple Mag	Coyote Tan
USA MOLLE		
37CL04MC	S.T.R.I.K.E. M4/M16 Triple Mag	MultiCam®
37CL040D	S.T.R.I.K.E. M4/M16 Triple Mag	Olive Drab



M4/M16 DOUBLE MAG POUCH (HOLDS 4)

Part Number	Description	Color	NSN#
MOLLE			
37CL03BK	S.T.R.I.K.E. M4/M16 Dble Mag	Black	8465-01-560-4128
37CL03MC	S.T.R.I.K.E. M4/M16 Dble Mag	MultiCam®	
37CL03OD	S.T.R.I.K.E. M4/M16 Dble Mag	Olive Drab	



TIER STACKED M16/M4/P MAG POUCH

- Holds two M16 magazines
- Stair-stepped configuration for easy access
- Open top with bungee retention
- Grommets for drainage
- S.T.R.I.K.E.® webbing on front for attaching additional items

Part Number	Description	Color
37CL118BK	Tier Stacked M16 Mag	Black
37CL118CT	Tier Stacked M16 Mag	Coyote Tan
37CL118OD	Tier Stacked M16 Mag	Olive Drab



18-ROUND POUCH

Part Number	Description	Color
37CL51CT	S.T.R.I.K.E. Shotgun 18RND	Coyote Tan
37CL51OD	S.T.R.I.K.E. Shotgun 18RND	Olive Drab



TRIPLE MP-5 MAG POUCH

Part Number	Description	Color
37CL106BK	Triple MP-5 Magazine Pouch	Black
37CL106MC	Triple MP-5 Magazine Pouch	MultiCam®



SMOKE GRENADE SINGLE POUCH

Part Number	Description	Color	NSN#	Dimensions
MOLLE				
37CL14BK	S.T.R.I.K.E. Smoke Grenade Single	Black	8465-01-561-3968	6"H x 3"W x 2"D
37CL140D	S.T.R.I.K.E. Smoke Grenade Single	Olive Drab	8465-01-550-3153	6"H x 3"W x 2"D



SINGLE FRAG GRENADE POUCH

Part Number	Description	Color	MSRP
37CL12BK	Single Frag Grenade Pouch	Black	\$6.95
37CL12CT	Single Frag Grenade Pouch	Coyote Tan	\$6.95
37CL120D	Single Frag Grenade Pouch	Olive Drab	\$6.95
37CL12MC	Single Frag Grenade Pouch	MultiCam®	\$9.95



DOUBLE FRAG GRENADE POUCH

Part Number	Description	Color	MSRP
37CL13BK	Double Frag Grenade Pouch	Black	\$12.95



DOUBLE 4MM GRENADE POUCH

Part Number	Description	Color	MSRP
37CL22BK	Double 40mm Grenade Pouch	Black	\$8.95



SIX ROUND 40MM GRENADE POUCH

Part Number	Description	Color
37CL59BK	6 Round 40mm Grenade Pouch	Black
37CL59CT	6 Round 40mm Grenade Pouch	Coyote Tan



FLASHBANG POUCH

Part Number	Description	Color	Dimensions	NSN#
MOLLE				
37CL54BK	S.T.R.I.K.E. Flashbang	Black	4.5"H x 2.5"W x 2.25"D	8465-01-560-4130
37CL54CT	S.T.R.I.K.E. Flashbang	Coyote Tan	4.5"H x 2.5"W x 2.25"D	
37CL54MC	S.T.R.I.K.E. Flashbang	MultiCam®	4.5"H x 2.5"W x 2.25"D	
37CL54OD	S.T.R.I.K.E. Flashbang	Olive Drab	4.5"H x 2.5"W x 2.25"D	



MEDIUM UTILITY POUCH

Part Number	Description	Color	Dimensions	NSN#
MOLLE				
37CL46BK	S.T.R.I.K.E. Medium Utility Pouch	Black	5.75"H x 9.5"W x 1"D	8465-01-560-4129



LARGE UTILITY POUCH WITH ZIPPER

Part Number	Description	Color	Dimensions	NSN#
MOLLE				
37CL60BK	S.T.R.I.K.E. Large utility w/Zipper	Black	7"H x 7.75"W x 3.25"D	
37CL60CT	S.T.R.I.K.E. Large utility w/Zipper	Coyote Tan	7"H x 7.75"W x 3.25"D	8465-01-553-7869
37CL60MC	S.T.R.I.K.E. Large utility w/Zipper	MultiCam®	7"H x 7.75"W x 3.25"D	
37CL60OD	S.T.R.I.K.E. Large utility w/Zipper	Olive Drab	7"H x 7.75"W x 3.25"D	



UTILITY POUCH

Part Number	Description	Color	Dimensions	NSN#
MOLLE				
37CL21BK	S.T.R.I.K.E. Utility	Black	9"W x 5.25"H x 3.25"D	8465-01-517-2976
37CL21CT	S.T.R.I.K.E. Utility	Coyote Tan	9"W x 5.25"H x 3.25"D	8465-01-554-2842
37CL21MC	S.T.R.I.K.E. Utility	MultiCam®	9"W x 5.25"H x 3.25"D	
37CL21OD	S.T.R.I.K.E. Utility	Olive Drab	9"W x 5.25"H x 3.25"D	



UPRIGHT GP POUCH

Part Number	Description	Color	Dimensions
MOLLE			
37CL52BK	S.T.R.I.K.E. Upright GP	Black	8" H x 5.5" W x 3.5" D
37CL52MC	S.T.R.I.K.E. Upright GP	MultiCam®	8" H x 5.5" W x 3.5" D
37CL52OD	S.T.R.I.K.E. Upright GP	Olive Drab	8" H x 5.5" W x 3.5" D



SMALL RADIO/GPS POUCH

Part Number	Description	Color	Dimensions	NSN#
MOLLE				
37CL35BK	S.T.R.I.K.E. Small Radio/GPS	Black	7"H x 3"W x 1.5"D	8465-01-581-3793
37CL35CT	S.T.R.I.K.E. Small Radio/GPS	Coyote Tan	7"H x 3"W x 1.5"D	
37CL35MC	S.T.R.I.K.E. Small Radio/GPS	MultiCam®	7"H x 3"W x 1.5"D	
37CL35OD	S.T.R.I.K.E. Small Radio/GPS	Olive Drab	7"H x 3"W x 1.5"D	8465-01-581-3790



RADIO POUCH MBTR

Part Number	Description	Color	Dimensions
MOLLE			
37CL20BK	S.T.R.I.K.E. Radio	Black	7.25"H x 3.5"W x 1.5"D
37CL20CT	S.T.R.I.K.E. Radio	Coyote Tan	7.25"H x 3.5"W x 1.5"D
37CL20MC	S.T.R.I.K.E. Radio	MultiCam®	7.25"H x 3.5"W x 1.5"D
37CL20OD	S.T.R.I.K.E. Radio	Olive Drab	7.25"H x 3.5"W x 1.5"D



PRC-112 POUCH

Part Number	Description	Color	Dimensions	NSN#
MOLLE				
37CL26BK	S.T.R.I.K.E. Radio PRC-112	Black	9"H x 3.5"W x 2"D	
37CL26CT	S.T.R.I.K.E. Radio PRC-112	Coyote Tan	9"H x 3.5"W x 2"D	8465-01-554-2843
37CL26OD	S.T.R.I.K.E. Radio PRC-112	Olive Drab	9"H x 3.5"W x 2"D	



NALGENE® BOTTLE UTILITY POUCH

Part Number	Description	Color	Dimensions
MOLLE			
37CL70BK	S.T.R.I.K.E. Utility Pouch w/Nalgene Pocket	Black	9"W x 5.25"H x 3.25"D



CUFF/MAG/LIGHT POUCH

Part Number	Description	Color
37CL55BK	S.T.R.I.K.E. Cuff/Mag/Light	Black



ADMIN/FLASHLIGHT POUCH

- Loop panel and S.T.R.I.K.E.® webbing on front for identification and IR markers
- Large main compartment and smaller compartment with elastic loops for securing items
- Flashlight pocket with adjustable lid fits tactical handheld lights
- Grommets for drainage and attaching lanyards/dummy cords
- Dimensions: 7"H x 7.5"W

Part Number	Description	Color
37CL114BK	Admin/Flashlight Pouch	Black
37CL114CT	Admin/Flashlight Pouch	Coyote Tan
37CL114MC	Admin/Flashlight Pouch	MultiCam®
37CL114OD	Admin/Flashlight Pouch	Olive Drab



ADMIN/COMPASS/FLASHLIGHT POUCH

Part Number	Description	Color	Dimensions
MOLLE			
37CL32BK	S.T.R.I.K.E. Admin/Compass/Flash	Black	7.25" H x 7.25"W
37CL32OD	S.T.R.I.K.E. Admin/Compass/Flash	Olive Drab	7.25" H x 7.25"W



GLADIUS/ALLY® PLR FLASHLIGHT POUCH

- A pouch designed specifically for the Blackhawk Gladius and Ally

Part Number	Description	Color
38CL91BK	Gladius/Ally PLR Flashlight Pouch	Black



FOLDING DUMP POUCH

- Hook & loop attachment
- Belt-mounted folding/roll-up dump pouch
- Low-profile design for use as magazine dump pouch, evidence bag, flex cuff pouch, etc.
- Dimensions: 11”H x 8”W x 5”D

Part Number	Description	Color
37CL77CT	Folding Dump Pouch	Coyote Tan



S.T.R.I.K.E.® ROLL-UP DUMP POUCH

- Internal elastic loops for light sticks, shotgun shells, etc.
- Shock cord cinches tight to retain contents
- Stiffener in opening of main compartment holds pouch open for easy access
- Grommets for drainage
- S.T.R.I.K.E.® webbing on front for attaching additional items
- Dimensions: 10”H x 8.5”W x 3.75”D

Part Number	Description	Color
37CL117BK	Roll-up MOLLE Dump Pouch	Black
37CL117CT	Roll-up MOLLE Dump Pouch	Coyote Tan
37CL117MC	Roll-up MOLLE Dump Pouch	MultiCam®
37CL117OD	Roll-up MOLLE Dump Pouch	Olive Drab



POP-UP TOURNIQUET POUCH

- Quick access to tourniquet (not included)
- Internal 1.5” strap wraps under tourniquet and through lid for easy tourniquet removal
- Dimensions: 4.75”H x 2.25”W x 2.25”D

Part Number	Description	Color
MOLLE		
37CL107BK	Pop-up Tourniquet Pouch	Black
37CL107CT	Pop-up Tourniquet Pouch	Coyote Tan
37CL107OD	Pop-up Tourniquet Pouch	Olive Drab



COMPACT MEDICAL POUCH

- Removable internal panel with multiple loops to organize and retain medical supplies
- Encased foam handle for quick one-handed operation
- Red zipper pulls for medical content identification
- Grommets for drainage
- 2.5" x 2.5" loop panel for patch attachment
- Can be configured for belt wear
- Dimensions: 6.75"H x 4.25"W x 2"D

Part Number	Description	Color
37CL124BK	Compact Medical Pouch	Black
37CL124CT	Compact Medical Pouch	Coyote Tan



QUICK RELEASE MED POUCH

- Removable medical pouch disconnects quickly from platform
- Side-release buckle for additional security
- Red handle and zipper pulls for medical content identification
- Grommets for drainage
- Internal pocket and elastic straps for stowing critical supplies
- 2.5" x 2.5" loop on front for patch attachment
- Can be configured for belt wear
- Dimensions: 7"H x 5.5"W x 3"D

Part Number	Description	Color
37CL116BK	Quick Release Medical Pouch	Black
37CL116CT	Quick Release Medical Pouch	Coyote Tan
37CL116MC	Quick Release Medical Pouch	MultiCam®
37CL116OD	Quick Release Medical Pouch	Olive Drab



MEDICAL POUCH

Part Number	Description	Color	Dimensions	NSN#
MOLLE				
37CL18BK	S.T.R.I.K.E. Medical	Black	7.5"H x 5.5"W x 3.5"D	8465-01-562-4845
37CL18CT	S.T.R.I.K.E. Medical	Coyote Tan	7.5"H x 5.5"W x 3.5"D	8465-01-561-3969



MISC.

C.I.A. LANYARD



- Credentials Information Access Lanyard is perfect for CAC cards and other ID
- Two-sided smart-card holder protects up to two access cards
- 5mm Lanyard with detachable 3mm rope end

Part Number	Description	Color
90ID03BK	C.I.A. Lanyard	Black

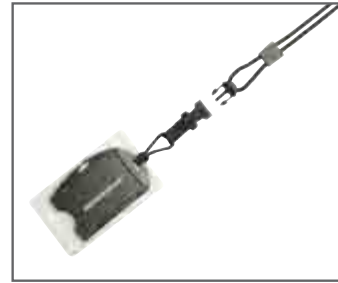

PERSONAL RETENTION LANYARD

- Tubular webbing and internal shock cord
- Five bar tacks on each end secure internal shock cord and create carabiner loops

Part Number	Description	Color	NSN#
9904530D	15" relaxed/19" stretch	Olive Drab	4240-01-502-9401
990802BK	23" relaxed/31.5" stretch	Black	4240-01-613-1278



CARABINERS



- Working load strength force rated to 26kN in excess of 5,800 lbs.
- Black anodized aluminum
- Non-packaged bulk orders available

Part Number	Description	Color	NSN#
98NC00BK	Non-locking carabiner	Black	
98LC00BK	Locking carabiner	Black	8465-01-529-6148



ID-BADGE HANGER

- Lid is secured with hook & loop
- Two slip pockets for passport, ID, business cards, money, etc.
- Pen pouch for quick access

Part Number	Description	Color	NSN#
90ID01BK	5.3" x 3.8" Badge Hanger	Black	8455-01-529-5688



IDENTIFICATION PANEL BASE

- Hook & loop panel for attaching ID panels to S.T.R.I.K.E.® webbing
- Mounts with Speed Clips™ (two included)
- Dimensions: 2.5”H x 5.5”W

Part Number	Description	Color
38CL42BK	Identification Panel Base	Black



RED CROSS MEDIC ID PATCH

- Smooth embroidery (not printed)
- Hook backing with loop panel included
- Can be sewn to clothing or gear
- Dimensions: 2.5”H x 2.5”W

Part Number	Description	Color
90RC00BK	Red Cross Medic ID Patch	Black



AMERICAN FLAG PATCH

- Embroidered with matching border
- Hook & loop panel for quick on/off capability
- Dimensions: 2”H x 3”W

Part Number	Description	Color
90SAFV-R	American Flag Patch-Reversed	Olive Drab
90RWBV-R	American Flag Patch-Reversed	Full Color
90DTFV-R	American Flag Patch-Reversed	Coyote Tan
90SAFV	American Flag Patch	Olive Drab
90RWBV	American Flag Patch	Full Color
90DTFV	American Flag Patch	Coyote Tan



90SAFV-R
Reversed
Subdued Olive Drab



90RWBV-R
Reversed
Full Color



90DTFV-R
Reversed
Subdued Coyote Tan



90SAFV
Standard
Subdued Olive Drab



90RWBV
Standard
Full Color



90DTFV
Standard
Subdued Coyote Tan



BLACKHAWK